

# Control module NIBE SMO 40

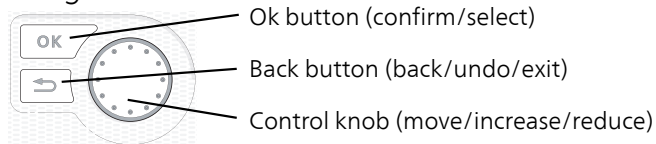

## Quick guide

### Navigation



A detailed explanation of the button functions can be found on page 36.

How to scroll through menus and make different settings is described on page 38.

### Set the indoor climate

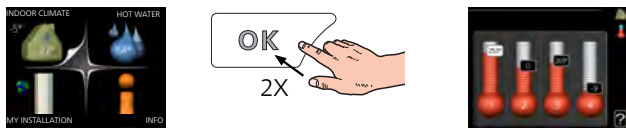

The mode for setting the indoor temperature is accessed by pressing the OK button twice, when in the start mode in the main menu.

### Increase hot water volume



To temporarily increase the amount of hot water (if a hot water heater is installed to your SMO 40), first turn the control knob to mark menu 2 (water droplet) and then press the OK button twice.

# Table of Contents

1	<i>Important information</i> _____	4	Cooling mode _____	34
	Safety information _____	4	Start-up and inspection _____	35
	Symbols _____	4		
	Marking _____	4	7 <i>Control - Introduction</i> _____	36
	Serial number _____	5	Display unit _____	36
	Recovery _____	5	Menu system _____	37
	Inspection of the installation _____	6	8 <i>Control</i> _____	40
	System solutions _____	7	Menu 1 - INDOOR CLIMATE _____	40
2	<i>Delivery and handling</i> _____	9	Menu 2 - HOT WATER _____	41
	Wall installation _____	9	Menu 3 - INFO _____	41
	Supplied components _____	9	Menu 4 - MY SYSTEM _____	42
			Menu 5 - SERVICE _____	43
3	<i>The Control Module Design</i> _____	10	9 <i>Service</i> _____	55
	Component positions _____	10	Service actions _____	55
	Electrical components _____	10	10 <i>Disturbances in comfort</i> _____	58
4	<i>Pipe connections</i> _____	11	Info-menu _____	58
	General _____	11	Manage alarm _____	58
	Compatible NIBE air/water heat pumps _____	12	Additional heating only _____	60
	Symbol key _____	12	11 <i>Accessories</i> _____	61
	Temperature sensor installation on pipe _____	13	12 <i>Technical data</i> _____	64
	Fixed condensing _____	13	Dimensions _____	64
	Docking alternatives _____	13	Technical specifications _____	65
5	<i>Electrical connections</i> _____	19	Energy labelling _____	66
	General _____	19	Electrical circuit diagram _____	67
	Accessibility, electrical connection _____	20	<i>Item register</i> _____	74
	Cable lock _____	21	<i>Contact information</i> _____	78
	Connections _____	22		
	Optional connections _____	27		
	Connecting accessories _____	33		
6	<i>Commissioning and adjusting</i> _____	34		
	Preparations _____	34		
	Commissioning _____	34		
	Commissioning with additional heating only _____	34		
	Check the reversing valve _____	34		
	Check AUX socket _____	34		

# 1 Important information

## Safety information

This manual describes installation and service procedures for implementation by specialists.

The manual must be left with the customer.

This appliance can be used by children aged from 8 years and above and persons with reduced physical, sensory or mental capabilities or lack of experience and knowledge if they have been given supervision or instruction concerning use of the appliance in a safe way and understand the hazards involved. Children shall not play with the appliance. Cleaning and user maintenance shall not be made by children without supervision.

Rights to make any design or technical modifications are reserved.

©NIBE 2019.

SMO 40 must be installed via an isolator switch. The cable area has to be dimensioned based on the fuse rating used.

If the supply cable is damaged, only NIBE, its service representative or similar authorised person may replace it to prevent any danger and damage.

## Symbols



### NOTE

This symbol indicates danger to person or machine .



### Caution

This symbol indicates important information about what you should consider when installing or servicing the installation.



### TIP

This symbol indicates tips on how to facilitate using the product.

## Marking

**CE** The CE mark is obligatory for most products sold in the EU, regardless of where they are made.

**IP21** Classification of enclosure of electro-technical equipment.



Danger to person or machine.



Read the User Manual.

# Serial number

The serial number can be found on the top of the cover for the control module and in the info menu (menu 3.1).

Serial number



## Caution

You need the product's (14 digit) serial number for servicing and support.

# Recovery



Leave the disposal of the packaging to the installer who installed the product or to special waste stations.

Do not dispose of used products with normal household waste. It must be disposed of at a special waste station or dealer who provides this type of service.

Improper disposal of the product by the user results in administrative penalties in accordance with current legislation.

# Inspection of the installation









Current regulations require the heating installation to be inspected before it is commissioned. The inspection must be carried out by a suitably qualified person. In addition, fill in the page for the installation data in the User Manual.

✓	Description	Notes	Signature	Date
	Electrical connections			
	Communication, heat pump			
	Connected supply 230 V			
	Outside sensor			
	Room sensor			
	Temperature sensor, hot water charging			
	Temperature sensor, hot water top			
	Temperature sensor, external flow line			
	Temperature sensor, external return line			
	Charge pump			
	Shuttle valve			
	AUX1			
	AUX2			
	AUX3			
	AUX4			
	AUX5			
	AUX6			
	AA3-X7			
	Dipswitch			
	Miscellaneous			
	Checking additional heater			
	Checking the function of the reversing valve			
	Checking charge pump function			
	Completed installation check of heat pump and associated equipment			

# System solutions

## COMPATIBLE PRODUCTS

The following combinations of products are recommended for control by SMO 40.

							
<i>Control module</i>	<i>Air/water heat pump</i>	<i>HW control</i>	<i>Accumulator with hot water heater</i>	<i>Circ. pump</i>	<i>Water heater</i>	<i>Addition</i>	<i>Volume vessel</i>
SMO 40	AMS 10-6 / HBS 05-6	VST 05	VPA 450/300 VPAS 300/450 VPA 300/200 VPA 450/300 VPAS 300/450	CPD 11-25/65 CPD 11-25/75	VPB 200 VPB 300 VPBS 300 VPB 500 VPB 750-2 VPB 1000	ELK 15 ELK 26 ELK 42	UKV 40 UKV 100 UKV 200 UKV 300 UKV 500
	AMS 10-8 / HBS 05-12						
	F2040 – 6						
	F2040 – 8						
	F2120 – 8						
	AMS 10-12 / HBS 05-12	VST 11					
	F2040 – 12						
	F2120 – 12						
	F2120 – 16						
	AMS 10-16 / HBS 05-16	VST 20					
	F2040 – 16						
	F2120 – 20						
					VPB 500 VPB 750-2 VPB 1000		

## COMPATIBLE AIR/WATER HEAT PUMPS

### *NIBE SPLIT HBS 05*

*AMS 10-6*                      *HBS 05-6*  
Part no. 064 205              Part no. 067 578

*AMS 10-8*                      *HBS 05-12*  
Part no. 064 033              Part no. 067 480

*AMS 10-12*                     *HBS 05-12*  
Part no. 064 110              Part no. 067 480

*AMS 10-16*                    *HBS 05-16*  
Part no. 064 035              Part no. 067 536

### *F2040*

*F2040-6*                        *F2040-8*  
Part no. 064 206              Part no. 064 109

*F2040-12*                      *F2040-16*  
Part no. 064 092              Part no. 064 108

### *F2120*

*F2120-8 1x230V*               *F2120-8 3x400V*  
Part no. 064 134              Part no. 064 135

*F2120-12 1x230V*              *F2120-12 3x400V*  
Part no. 064 136              Part no. 064 137

*F2120-16 3x400V*              *F2120-20 3x400V*  
Part no. 064 139              Part no. 064 141

Check the software version of compatible older NIBE air/water heat pumps, see page 12.



# 2 Delivery and handling

## Wall installation



### NOTE

For wall mounting, use screws suitable for the surface.

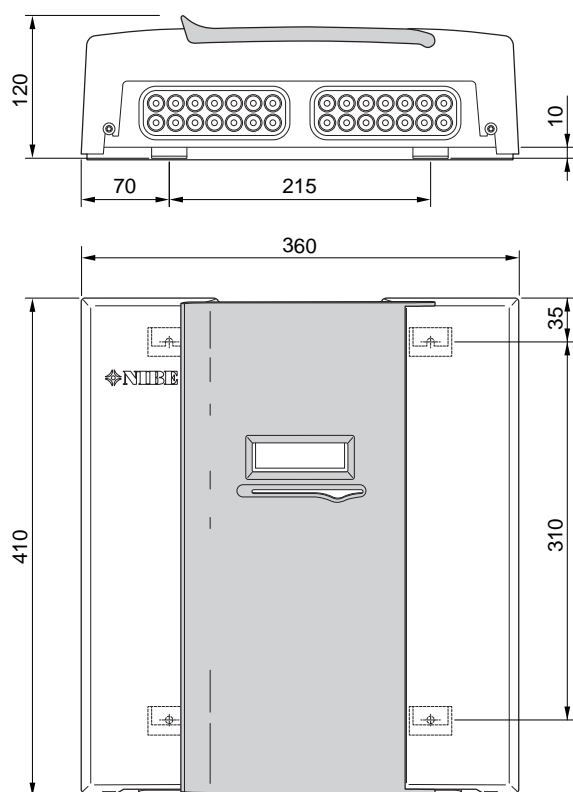

Use all mounting points and install SMO 40 upright flat against the wall without any part of the control module protruding beyond the edge of the wall.

Leave at least 100 mm free space around the control module to facilitate access and cable routing on installation and service.



### Caution

Screws for removing the front cover are reached from underneath.

## Supplied components



Outside sensor

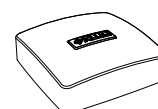

Room sensor

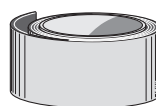

Insulation tape



Temperature sensor



Aluminium tape



Cable ties



Heating pipe paste



Current sensor



IHB SMO 40 Accessory board

# 3 The Control Module Design

## Component positions Electrical components

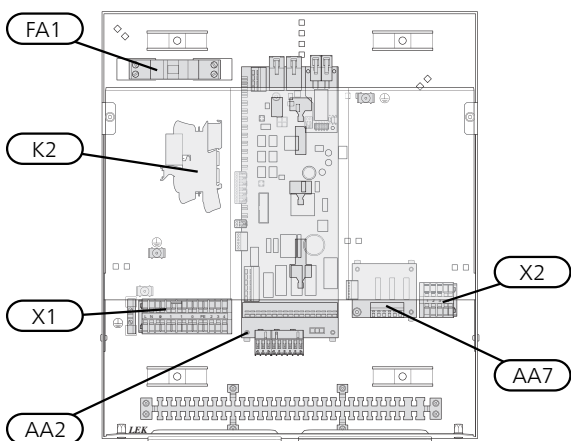
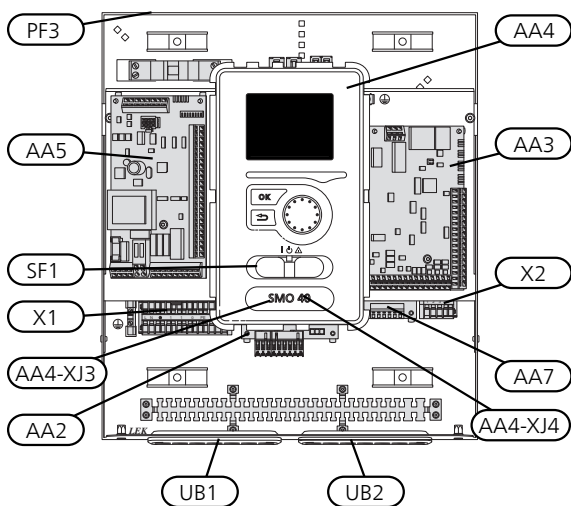

- AA2 Base card
- AA3 Input circuit board
- AA4 Display unit
  - AA4-XJ3 USB socket
  - AA4-XJ4 Service outlet (No function)
- AA5 Accessory card
- AA7 Extra relay circuit board
- FA1 Miniature circuit breaker, 10 A
- K2 Emergency mode relay
- X1 Terminal block, incoming electrical supply
- X2 Terminal block, AUX4 - AUX6
- SF1 Switch
- PF3 Serial number plate
- UB1 Cable grommet, incoming supply electricity, power for accessories
- UB2 Cable gland, signal

Designations in component locations according to standard IEC 81346-1 and EN 81346-2.

# 4 Pipe connections

## General

Pipe installation must be carried out in accordance with applicable regulations. See manual for compatible NIBE air/water heat pump for installation of the heat pump.

The pipe dimension should not be less than the recommended pipe diameter according to the table below. However, each system must be dimensioned individually to achieve the recommended system flows.

### MINIMUM SYSTEM FLOWS

The installation must be dimensioned at least to manage the minimum defrosting flow at 100% pump operation, see table.

<i>Air/water heat pump</i>	<i>Minimum flow during defrosting (100% pump speed (l/s))</i>	<i>Minimum recommended pipe dimension (DN)</i>	<i>Minimum recommended pipe dimension (mm)</i>
HBS 05-6/AMS 10-6	0.19	20	22
HBS 05-12/AMS 10-8	0.19	20	22
HBS 05-12/AMS 10-12	0.29	20	22
HBS 05-16/AMS 10-16	0.39	25	28

<i>Air/water heat pump</i>	<i>Minimum flow during defrosting (100% pump speed (l/s))</i>	<i>Minimum recommended pipe dimension (DN)</i>	<i>Minimum recommended pipe dimension (mm)</i>
F2120-8	0.27	20	22
F2120-8 (1x230V)	0.27	20	22
F2120-12	0.35	25	28
F2120-12 (1x230V)	0.35	25	28
F2120-16	0.38	25	28
F2120-20	0.38	32	35

<i>Air/water heat pump</i>	<i>Minimum flow during defrosting (100% pump speed (l/s))</i>	<i>Minimum recommended pipe dimension (DN)</i>	<i>Minimum recommended pipe dimension (mm)</i>
F2040-6	0.19	20	22
F2040-8	0.19	20	22
F2040-12	0.29	20	22
F2040-16	0.39	25	28



### NOTE

















An undersized system can result in damage to the machine and lead to malfunctions.

# Compatible NIBE air/water heat pumps

Compatible NIBE air/water heat pump has to be equipped with a control board that, as a minimum, has the software version given in the following list. The control board's version is shown in the heat pump's display (if applicable) at start-up.

<i>Product</i>	<i>Software version</i>
F2015	55
F2016	55
F2020	118
F2025	55
F2026	55
F2030	all versions
F2040	all versions
F2120	all versions
F2300	55
NIBE SPLIT HBS 05: AMS 10-6 + HBS 05-6 AMS 10-8 + HBS 05-12 AMS 10-12 + HBS 05-12 AMS 10-16 + HBS 05-16	all versions

# Symbol key

<i>Symbol</i>	<i>Meaning</i>
	Shut-off valve
	Tapping valve
	Trim valve
	Shunt / reversing valve
	Safety valve
	Temperature sensor
	Expansion vessel
	Pressure gauge
	Circulation pump
	Particle filter
	Auxiliary relay
	Compressor
	Heat exchanger
	Radiator system
	Domestic hot water
	Under floor heating systems
	Cooling system

# Temperature sensor installation on pipe

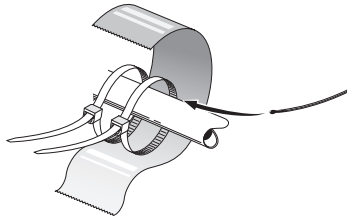

The temperature sensors are fitted using heat conductive paste, cable ties (the first cable tie is secured to the pipe in the middle of the sensor and the other cable tie is mounted approx. 5 cm after the sensor) and aluminium tape. Then insulate them using the enclosed insulation tape.



### NOTE

Sensor and communication cables must not be laid near power cables.

# Fixed condensing

If SMO 40 is to control the air/water heat pump in relation to the water heater with fixed condensing, you must connect an external supply temperature sensor (BT25), according to the description on page 26. Place the sensor in a suitable location in the tank. In addition, you must perform the following menu settings.

Menu	Menu setting (local variations may be required)
1.9.3.1 - min. flow line temp. heating	Desired temperature in the tank.
5.1.2 - max flow line temperature	Desired temperature in the tank.
5.11.1.2 - charge pump (GP12)	intermittent
4.2 - op. mode	manual

# Docking alternatives

SMO 40 can be connected with other products from NIBE in several different ways, some of which are shown below (accessories may be required).

Further option information is available at [nibe.eu](http://nibe.eu) and in the respective assembly instructions for the accessories used. See page 61 for a list of the accessories that can be used with SMO 40.

Installations with SMO 40 can produce heating and hot water. Cooling can also be produced, depending on which heat pump is used.

On cold days of the year when the access to energy from the air is reduced the additional heating can compensate and help to produce heat. The additional heating is also good to have as assistance if the heat pump ends up outside its working range or if it has been blocked for any reason.



### NOTE

The heating medium side and the domestic hot water side must be fitted with the necessary safety equipment in accordance with the applicable regulations.

This is the outline diagram. Actual installations must be planned according to applicable standards.

## EXPLANATION

AA25	SMO 40	BT64	Temperature sensor, cooling supply line <sup>2)</sup>
BT1	Outdoor sensor <sup>1)</sup>	CP6	Single jacket accumulator tank, cooling
BT6	Temperature sensor, hot water charging <sup>1)</sup>	GP13	Circulation pump, cooling
BT7	Temperature sensor, hot water top <sup>1)</sup>	QN12	Reversing valve, Cooling/Heating <sup>2)</sup>
BT25	Temperature sensor, external supply line <sup>1)</sup>	<i>QZ1</i>	<i>Hot water circulation</i>
BT50	Room sensor <sup>1)</sup>	AA25	Unit box with accessory card <sup>2)</sup>
BT63	Temperature sensor, external supply line after electric heater	BT70	Temperature sensor, outgoing hot water <sup>2)</sup>
BT71	Temperature sensor, external return line <sup>1)</sup>	GP11	Circulation pump, domestic hot water circulation
GP10	Circulation pump, Heating medium	FQ1	Mixer valve, hot water
QN10	Reversing valve, Hot water/Heating medium <sup>2)</sup>	FQ3	Mixing valve, hot water circulation
RM2	Non-return valve	RM1	Non-return valve
		RM23 to 24	Non-return valve
<i>CL11 till 12</i>	<i>Pool system 1 to 2</i>	RN1	Trim valve
AA25	Unit box with accessory card <sup>2)</sup>	RN20 to 21	Trim valve
BT51	Temperature sensor, pool <sup>2)</sup>	<i>Miscellaneous</i>	
EP5	Exchanger, pool	CM1	Expansion vessel closed, Heating medium
GP9	Circulation pump, pool	CP5	Buffer vessel (UKV)
HQ4	Particle filter, pool	CP10 to 11	Accumulator tank with hot water heating
QN10	Three way valve, pool <sup>2)</sup>	EB10	Hot water/additional water heater
RN10	Trim valve	EB20	Immersion heater
<i>EB1</i>	<i>Additional heat</i>	FL2	Safety valve, Heating medium
CM5	Expansion vessel	KA1	Auxiliary relay/Contactor
EB1	Immersion heater	RN10,	Trim valve
FL10	Safety valve	RN43,	
KA1	Auxiliary relay/Contactor <sup>2)</sup>	RN60 to 63	
RN11	Trim valve		
QM42 to 43	Shut-off valve		
QN11	Shunt valve for additional heat		
<i>EB101 on 104</i>	<i>Heat pump system</i>		
AA25	Unit box with accessory card <sup>2)</sup>		
BT3	Temperature sensor, return line <sup>3)</sup>		
BT12	Temperature sensor, condenser supply line <sup>3)</sup>		
EB101 to 104	Heat pump		
FL2	Safety valve, heating medium		
FL10	Safety valve		
GP12	Charge pump <sup>2)</sup>		
QM1	Drain valve, Heating medium		
QM31	Shut-off valve, Heating medium, Flow		
QM32	Shut off valve, Heating medium, Return		
QZ2	Filterball		
RM11	Non-return valve		
<i>EP21 to 22</i>	<i>Climate system 2 to 3</i>		
AA25	Unit box with accessory card <sup>2)</sup>		
BT2	Temperature sensor, heating medium supply <sup>2)</sup>		
BT3	Temperature sensor, heating medium return <sup>2)</sup>		
GP10	Circulation pump <sup>2)</sup>		
QN25	Shunt valve <sup>2)</sup>		
<i>EQ1</i>	<i>Cooling system</i>		
AA25	Unit box with accessory card <sup>2)</sup>		

1) Included in and supplied SMO 40

2) Included in and supplied accessory

3) Included in and supplied NIBE heat pump (can vary depending on heat pump).

Designations according to standard IEC 61346 and EN81346-2.

COMPATIBLE NIBE AIR/WATER HEAT PUMP TOGETHER WITH SMO 40 – DOCKING STEP-CONTROLLED ADDITIONAL HEAT BEFORE THE REVERSING VALVE FOR HOT WATER

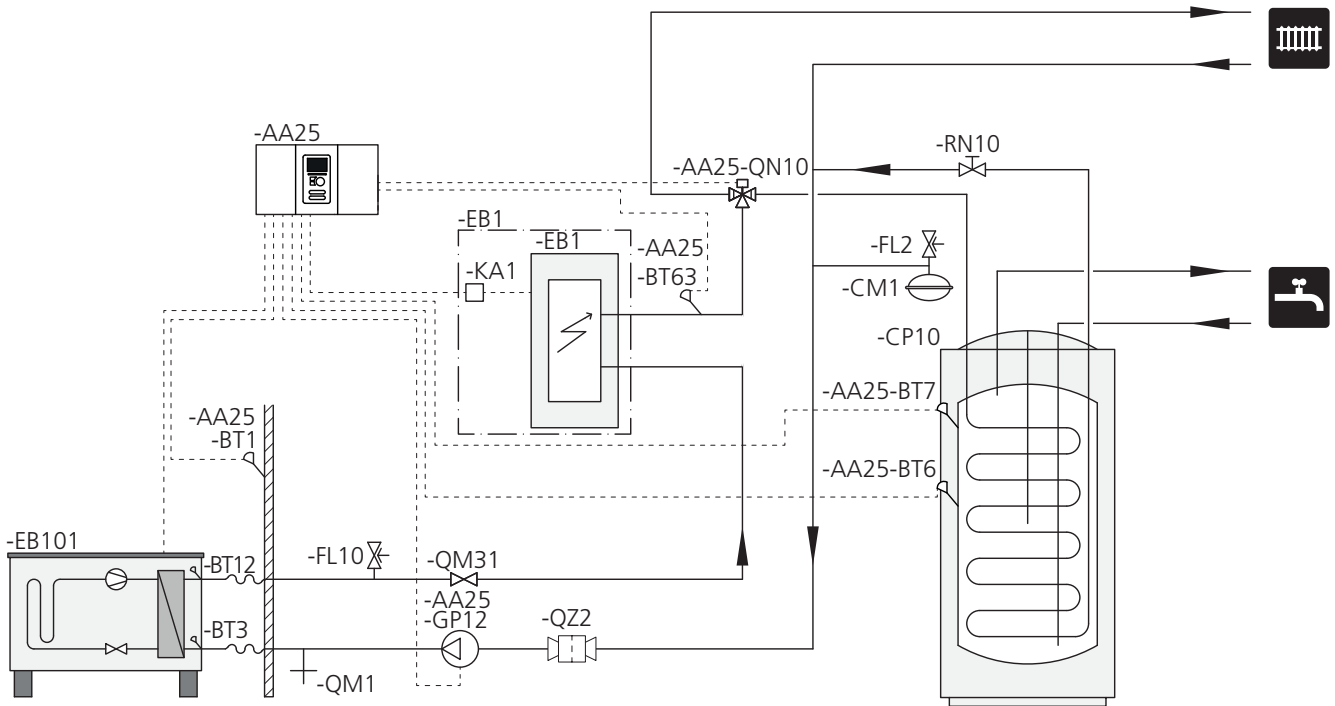

**Caution**

NIBE does not supply all components in this outline diagram.

This installation alternative is suitable for simpler installations with a focus on low installation costs.

SMO 40 (AA25) starts and stops the heat pump (EB101) to meet the heat and hot water demand of the installation. At simultaneous heating and hot water demand the reversing valve switches (AA25-QN10) periodically between the climate system and the water heater/accumulator tank (CP10). When the hot water heater/accumulator tank is fully charged (CP10), the reversing valve switches (AA25-QN10) to the climate system.

Additional heat (EB1) is connected automatically when the power demand for the installation exceeds the heat pump capacity. This is used for both heating and charging hot water.

The additional heat can also be used if a higher temperature in the hot water is required than the heat pump can produce.

COMPATIBLE NIBE AIR/WATER HEAT PUMP TOGETHER WITH SMO 40 – DOCKING STEP-CONTROLLED ADDITIONAL HEAT AFTER REVERSING VALVE FOR HOT WATER AND ACCESSORY FOR EXTRA CLIMATE SYSTEM, POOL AND COOLING

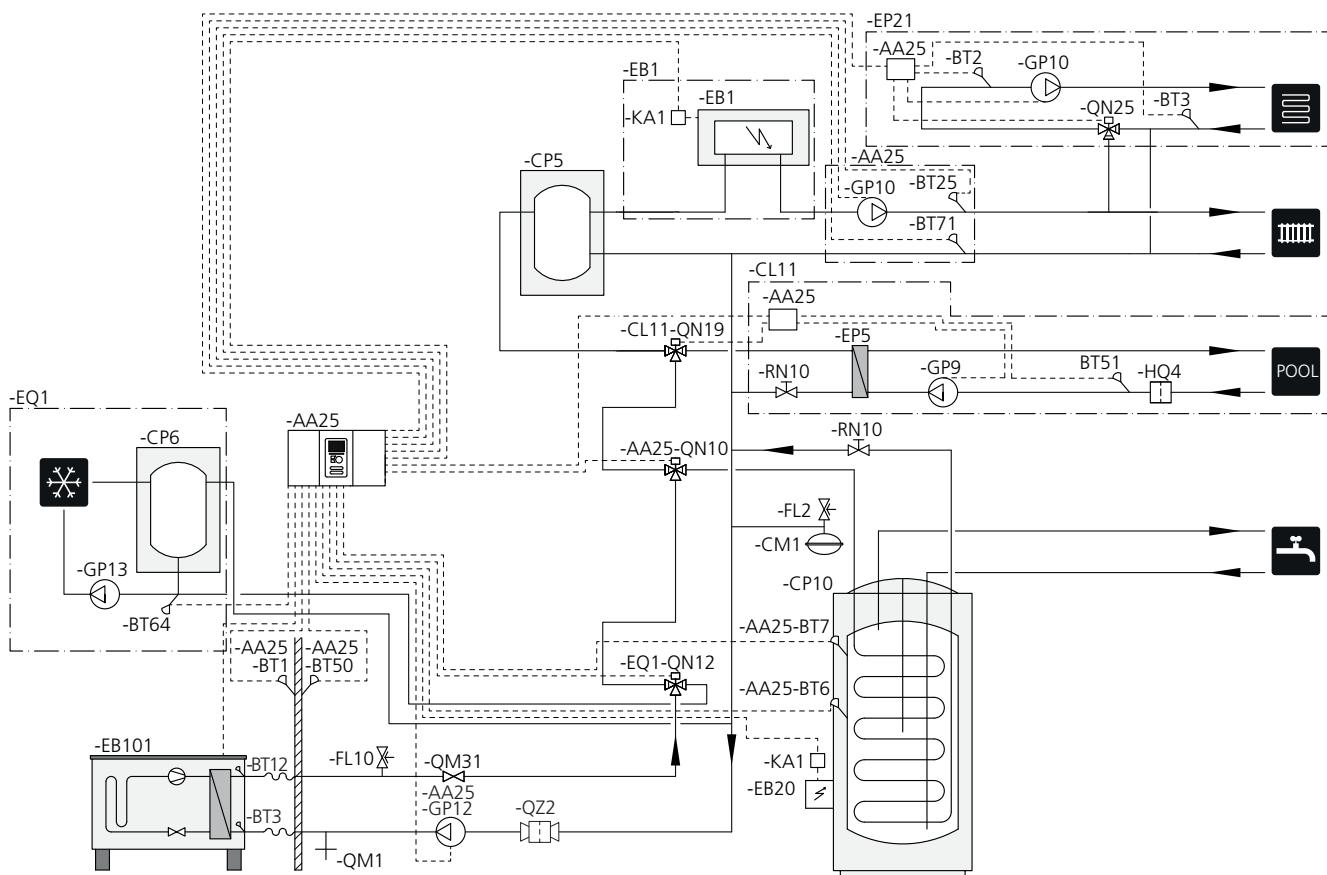

**Caution**

NIBE does not supply all components in this outline diagram.

This installation alternative is suitable for more complex installations with a focus on comfort.

SMO 40 (AA25) starts and stops the heat pump (EB101) to meet the heat and hot water demand of the installation. At simultaneous heating and hot water demand the reversing valve switches (AA25-QN10) periodically between the climate system and the water heater/accumulator tank (CP10). When the water heater/accumulator tank is fully charged (CP10), the reversing valve switches (AA25-QN10) to the climate system and pool. When the pool needs heating the reversing valve (CL11-QN19) switches from the climate system to the pool system.

Additional heat (EB1) is connected automatically when the energy demand exceeds the heat pump capacity. Immersion heater (EB20) in the water heater/accumulator tank (CP10) is used during the time to produce hot water if the heat pump (EB101) is used for heating the building at the same time.

The immersion heater (EB20) can also be used if a higher temperature of hot water is required than the heat pump can produce.

During cooling operation (requires compatible heat pump), the reversing valve (EQ1-QN12) switches to the cooling system (EQ1). If several demands occur while there is a cooling demand, the installation reacts differently. In event of a hot water demand, the reversing valve (EQ1-QN12) switches back and hot water is produced until the demand is fulfilled. In event of a heating demand, the reversing valve (EQ1-QN12) instead switches periodically between the demands. When the cooling demand is met, the reversing valve switches back to basic mode (heat/hot water).

Active cooling (in 4-pipe system) is selected in menu 5.4 - soft in/outputs.



COMPATIBLE NIBE AIR/WATER HEAT PUMPS TOGETHER WITH SMO 40 AND ELECTRIC HEATER AFTER REVERSING VALVE FOR HOT WATER AS WELL AS POOL AND EXTRA CLIMATE SYSTEM (FLOATING CONDENSING)

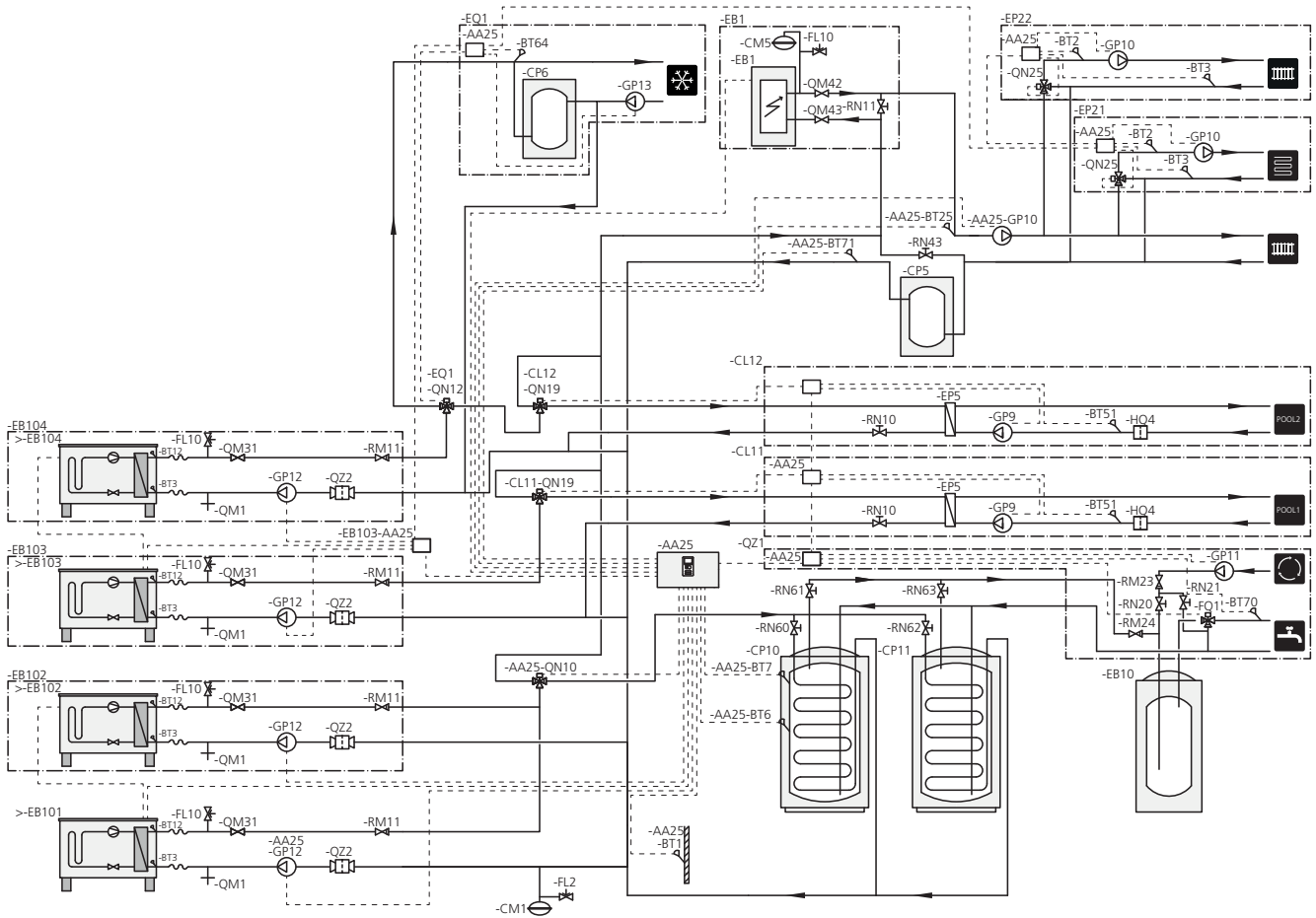

**Caution**

NIBE does not supply all components in this outline diagram.



**Caution**

Different types of demand (heating, hot water etc.) mean different supply and return temperatures as well as different flows to the heat pump.

When connecting pipes in installations with several compressors and different heating demands, ensure that these are separated so that different return temperatures are not mixed. Otherwise this can affect the heating installation's efficiency.

This installation's alternative is suitable for more complex installations with a focus on comfort.

SMO 40 (AA25) starts and stops the heat pumps (EB101) and (EB102) to meet the heating and hot water demands of the installation. The heat pump (EB103) is used for heating and pool heating and heat pump (EB104) is used for cooling, heating and pool heating.

At simultaneous heating and hot water demand the reversing valve switches (AA25-QN10) periodically between the climate system and the water heater/accumulator tank (CP10). When the hot water heater/accumulator tank is fully charged (CP10), the reversing valve switches (AA25-QN10) to the climate systems. When the pool needs heating the reversing valve (CL11-QN19) or (CL12-QN19) switches from the climate system to the pool system.

Additional heat (EB1) is connected automatically when the energy demand exceeds the heat pump capacity.

Additional water heating is obtained from the additional water heater (EB10).

During cooling operation (requires compatible heat pump), the reversing valve (EQ1-QN12) switches to the cooling system (EQ1). If several demands occur while there is a cooling demand, the installation reacts differently. In the event of a heating demand, the reversing valve (EQ1-QN12) instead switches periodically between the demands. When the cooling demand is met, the reversing valve switches back to basic mode (heat/hot water). In the event of a pool heating demand, the reversing valve (EQ1-QN12) switches back at the same

time as the reversing valve (CL12-QN19) switches to the pool system (CL12) and pool heating is produced until the demand is fulfilled.

# 5 Electrical connections

## General

- Disconnect SMO 40 before insulation testing the house wiring.
- If the building is equipped with an earth-fault breaker, SMO 40 should be equipped with a separate one.
- SMO 40 must be installed via a circuit breaker with a minimum breaking gap of 3 mm.
- For the electrical wiring diagram for the control module, see page .67.
- Use a three core, screened cable for communication with the heat pump.
- Communication and sensor cables to external connections must not be laid close to high current cables.
- The minimum area of communication and sensor cables to external connections must be 0.5 mm<sup>2</sup> up to 50 m, for example EKKX, LiYY or equivalent.
- When cable routing into SMO 40, cable grommets (UB1 and UB2, marked in image) must be used.



### NOTE

The switch (SF1) must not be moved to "I" or "⚠" until the boiler water has been filled in the system. The compressor in the heat pump and any external additional heat can be damaged.



### NOTE

Electrical installation and any servicing must be carried out under the supervision of a qualified electrician. Disconnect the current using the circuit breaker before carrying out any servicing. Electrical installation and wiring must be carried out in accordance with the applicable provisions. When installing SMO 40, NIBE's air/water heat pump and any additional heat must be disconnected from the power supply.



### Caution

See outline diagram for your system for physical location of the temperature sensor that is to be installed.



### Caution

The relay outputs on the accessory board (AA5) may be subjected to a max load of 2 A (230 V) in total.

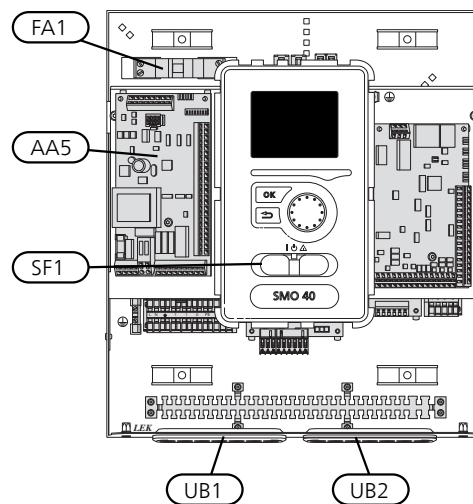

### MINIATURE CIRCUIT-BREAKER

The control module operating circuit and parts of its internal components are internally fused by a miniature circuit breaker (FA1).

# Accessibility, electrical connection

The cover of the control module is opened using a Torx 25 screwdriver. Assembly takes place in the reverse order.

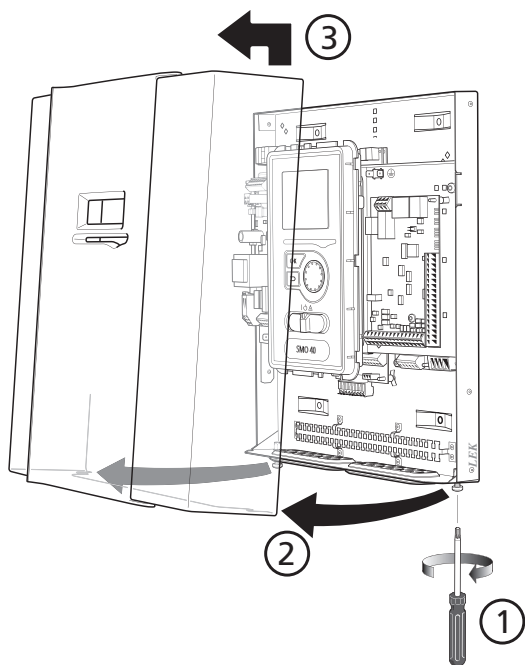

## TIP

The cover to access the base board is opened using a Torx 25 screwdriver.

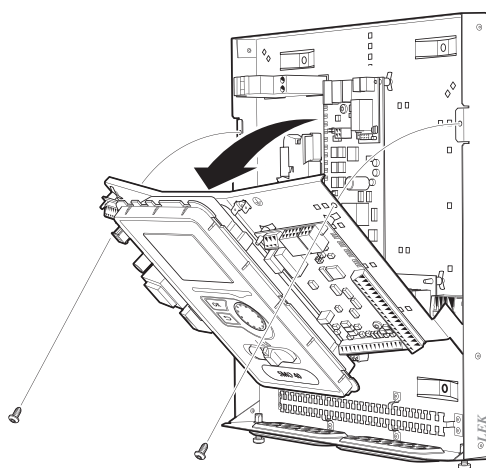

The display may need to be moved for easier access when connecting electrics. This is easily done by following these steps.

1.

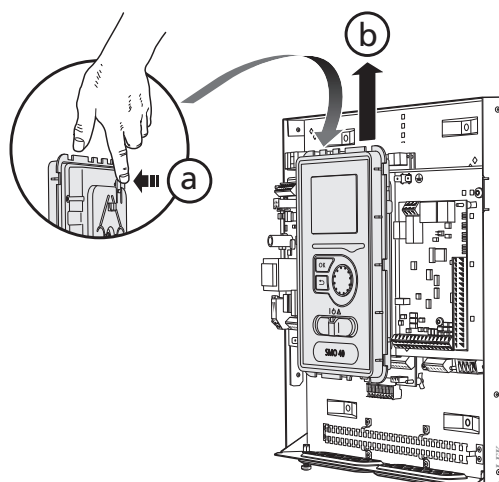

Press in the catch on the upper rear side of the display unit towards you (a) and move the display unit upwards (b) so that the mountings unhook from the panel.

2.

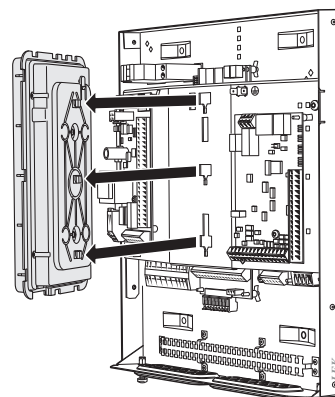

Lift the display unit from its mountings.

3.

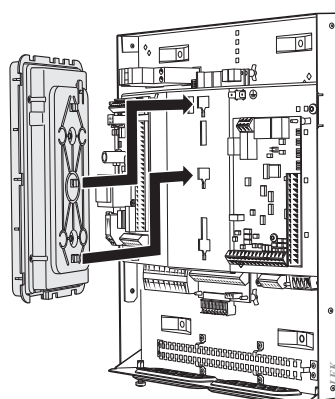

Align the two lower mountings on the reverse of the display unit with the two upper holes in the panel as illustrated.

4.

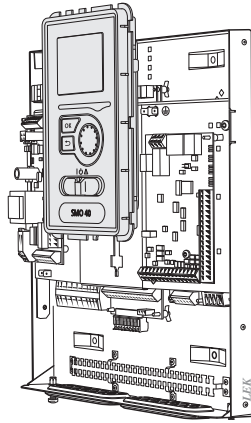

Secure the display on the panel.

5. When the electrical connection is ready the display must be reinstalled with three mounting points again, otherwise the front cover cannot be installed.

## Cable lock

Use a suitable tool to release/lock cables in the heat pump terminal blocks.

### TERMINAL BLOCK ON THE ELECTRICAL CARD

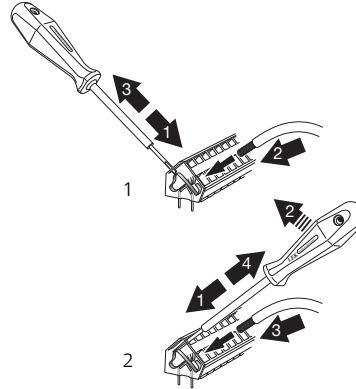

### TERMINAL BLOCK

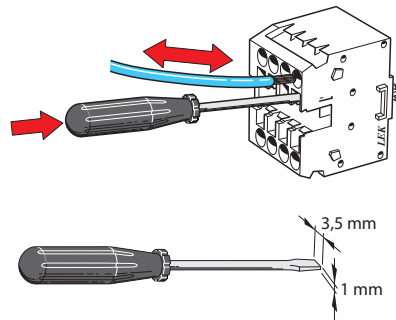

# Connections



## NOTE

To prevent interference, unscreened communication and/or sensor cables to external connections must not be laid closer than 20 cm from high voltage cables.

## POWER CONNECTION

SMO 40 must be installed via an isolator switch with a minimum breaking gap of 3mm. Minimum cable area must be sized according to the fuse rating used.

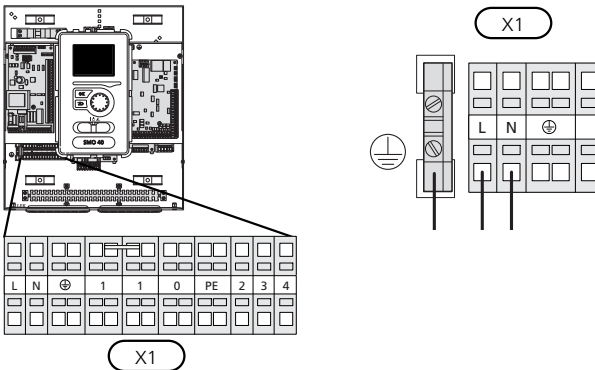

## TARIFF CONTROL

If there is a loss of voltage to the compressor in the heat pump for a certain period, simultaneous blocking of this must take place via a software-controlled input (AUX input) in order to avoid alarms, see page 31.

## CONNECTING THE CHARGE PUMP FOR THE HEAT PUMP 1 AND 2

Connect circulation pump (EB101-GP12) to terminal block X4:5 (PE), X4:6 (N) and X4:7 (230 V) on the base board (AA2) as illustrated.

Control signal for (EB101-GP12) is connected to terminal block X4:7 (GND) and X4:8 (PWM) on the input board (AA3) as illustrated.

If two heat pumps are connected to SMO 40, the circulation pump (EB102-GP12) must be connected to terminal block X4:12 (PE), X4:13 (N) and X4:15 (230 V) on the base board (AA2) as illustrated. Control signal for (EB102-GP12) is then connected to terminal block X4:5 (GND) and X4:6 (PWM) on the input board (AA3) as illustrated.



## TIP

Two charge pumps (four if the internal accessory board is used) can be connected to and controlled by SMO 40. Several charge pumps can be connected if accessory boards (AXC) are used, two pumps per board.

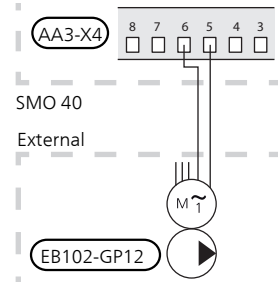
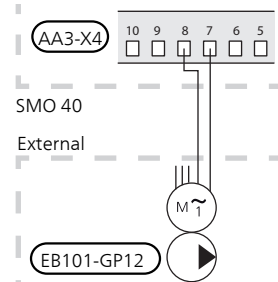
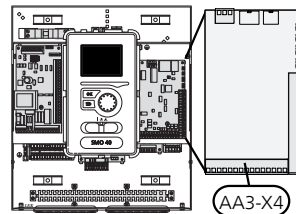
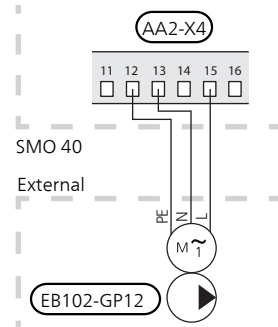
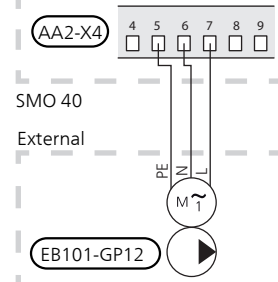
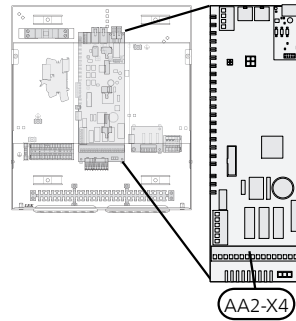

## COMMUNICATION WITH HEAT PUMP

Connect the heat pump (EB101) with a screened three core cable to terminal block X4:1 (A), X4:2 (B) and X4:3 (GND) on the accessory board (AA5) as illustrated.

If several heat pumps are to be connected to SMO 40 these must be connected in cascade as illustrated.



### Caution

Up to 8 heat pumps can be controlled by SMO 40.



### Caution

It is possible to combine various NIBE air/water heat pumps, of different sizes and models, with each other, effective from software version 8319.

With an earlier software version (than version 8319), an air/water heat pump with an inverter-controlled compressor can only be combined with other inverter-controlled heat pumps of the same model.

### Connecting to the heat pump

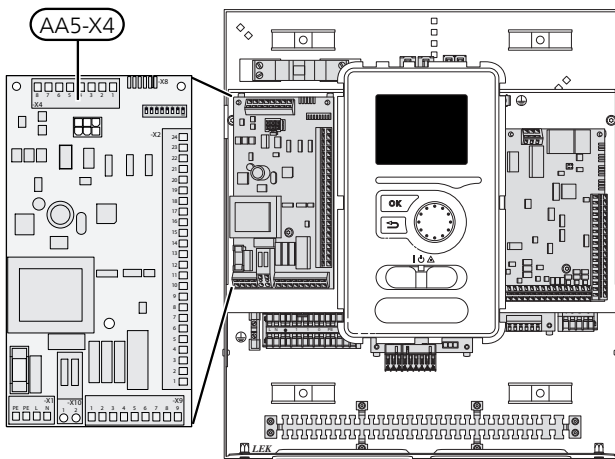

F2040

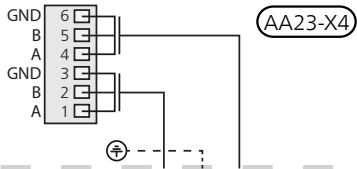

F2040

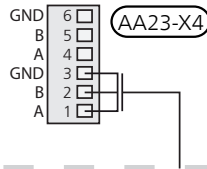

F2030

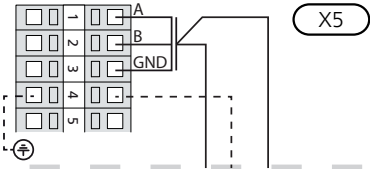

F2030

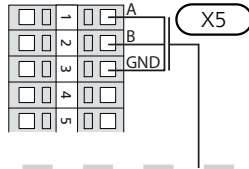

F2016/F2026

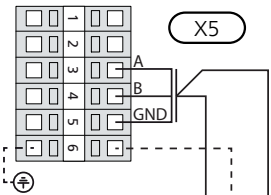

F2016/F2026

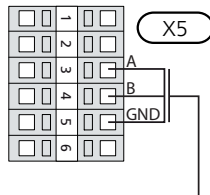

F2015/F2020/F2025/F2300

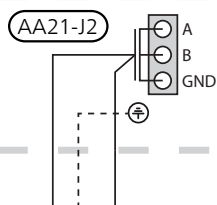

F2015/F2020/F2025/F2300

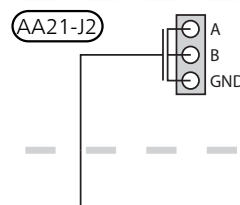

F2120

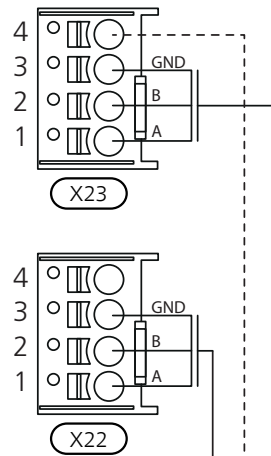

F2120

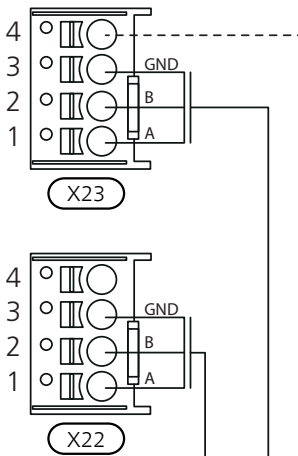

SMO 40

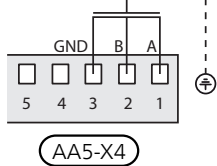



## OUTSIDE SENSOR

Install the outdoor temperature sensor (BT1) in the shade on a wall facing north or north-west, so it is unaffected by the morning sun for example.

Connect the sensor to terminal block X6:1 and X6:2 on the input board (AA3). Use a twin core cable with a cable area of at least 0.5 mm<sup>2</sup>.

If a conduit is used it must be sealed to prevent condensation in the sensor capsule.

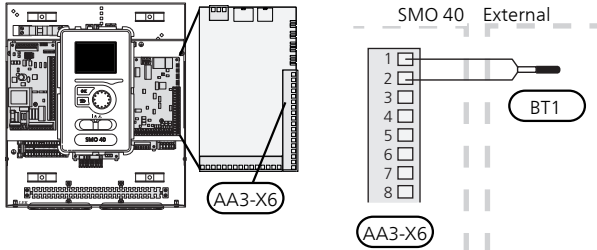

## ROOM SENSOR

SMO 40 comes with a room sensor (BT50). The room sensor has a number of functions:

1. Shows current room temperature in the control module display.
2. Provides the option of changing the room temperature in °C.
3. Provides the option of fine-tuning the room temperature.

Install the sensor in a neutral position where the set temperature is required. A suitable location is on a free inner wall in a hall approx. 1.5 m above the floor. It is important that the sensor is not prevented from measuring the correct room temperature by being located, for example, in a recess, between shelves, behind a curtain, above or close to a heat source, in a draft from an external door or in direct sunlight. Closed radiator thermostats can also cause problems.

The control module operates without the sensor, but if you want to read off the home's indoor temperature in the control module's display, the sensor must be installed. Connect the room sensor to terminal block X6:3 and X6:4 on the input board (AA3).

If the sensor is to be used to change the room temperature in °C and/or to fine-tune the room temperature, the sensor must be activated in menu 1.9.4.

If the room sensor is used in a room with underfloor heating, it should only have an indicative function, not control of the room temperature.

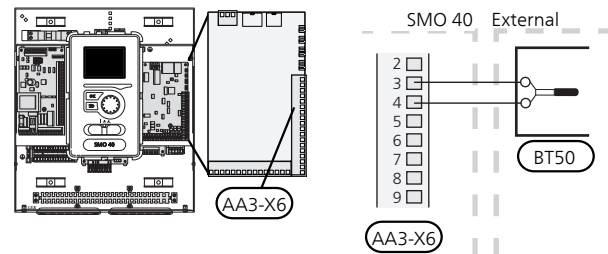

### Caution

Changes of temperature in accommodation take time. For example, short time periods in combination with underfloor heating will not give a noticeable difference in room temperature.

## TEMPERATURE SENSOR, HOT WATER CHARGING

The temperature sensor, hot water charging (BT6) is placed in the submerged tube on the water heater.

Connect the sensor to terminal block X6:7 and X6:8 on the input board (AA3). Use a twin core cable with a cable area of at least 0.5 mm<sup>2</sup>.

Hot water charging is activated in menu 5.2 or in the start guide.

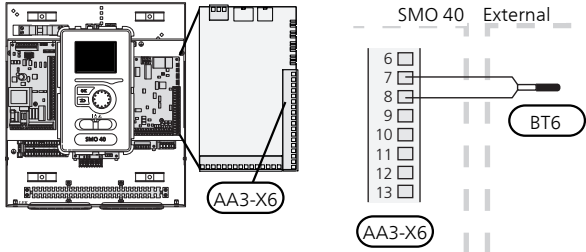

## TEMPERATURE SENSOR, HOT WATER TOP

A temperature sensor for hot water top (BT7) can be connected to SMO 40 to show the water temperature at the top of the tank (if it is possible to install a sensor at the top of the tank).

Connect the sensor to terminal block X6:15 and X6:16 on the input board (AA3). Use a twin core cable with a cable area of at least 0.5 mm<sup>2</sup>.

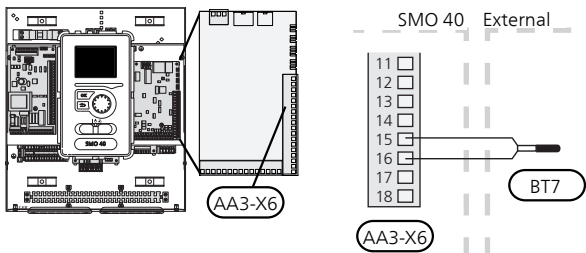

## TEMPERATURE SENSOR, EXTERNAL FLOW LINE

Connect temperature sensor, external supply line (BT25) (required for additional heat after reversing valve (QN10)), to terminal block X6:5 and X6:6 on the input board (AA3). Use a twin core cable with a cable area of at least 0.5 mm<sup>2</sup>.

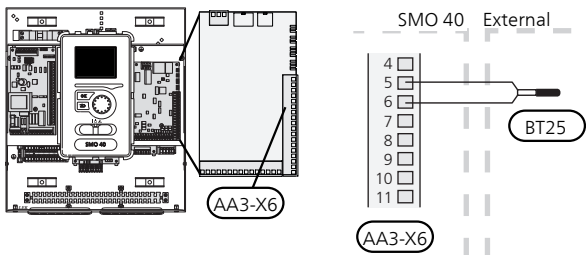

## TEMPERATURE SENSOR, EXTERNAL RETURN LINE

Connect temperature sensor, external return line (BT71) to terminal block X6:17 and X6:18 on the input board (AA3). Use a twin core cable with a cable area of at least 0.5 mm<sup>2</sup>.

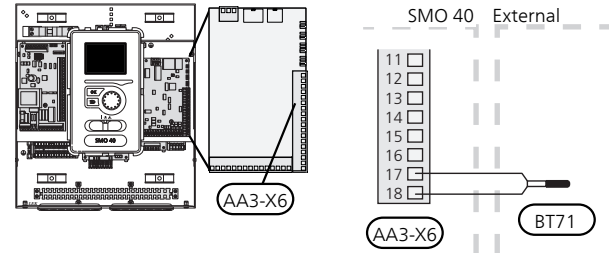

### Caution

For docking that requires connection of other sensors, see "Possible selection for AUX inputs" on page 30.

# Optional connections

## LOAD MONITOR

When many power consumers are connected in the property at the same time as the electric additional heat is in operation, there is a risk of the property's main fuses tripping. SMO 40 has an integrated load monitor that controls the power steps for the electric additional heat by disconnecting step by step in event of overload in a phase. Reconnection occurs when other current consumption is reduced.

### Connecting current sensors

A current sensor (BE1 - BE3) must be installed on each incoming phase conductor into the electrical distribution unit, to measure the current. The electrical distribution unit is an appropriate installation point.

Connect the current sensors to a multi-core cable in an enclosure next to the electrical distribution unit. Use unscreened multi-core cable of at least 0.5 mm<sup>2</sup>, from the enclosure to SMO 40.

Connect the cable to the input board (AA3) on terminal block X4:1-4 where X4:1 is the common terminal block for the three current sensors.

The value for the size of the fuse is set in menu 5.1.12 to correspond with the size of the property's main fuse. Here it is also possible to adjust the current sensor's transformer ratio.

Enclosed current sensors have a transformer ratio of 300 and, if these are used, the incoming current must not exceed 50 A.



### NOTE

The voltage from the current sensor to the input board must not exceed 3.2 V.

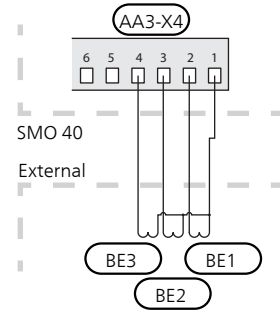
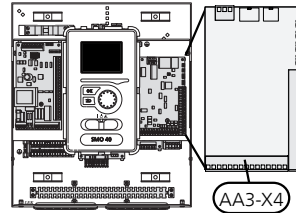
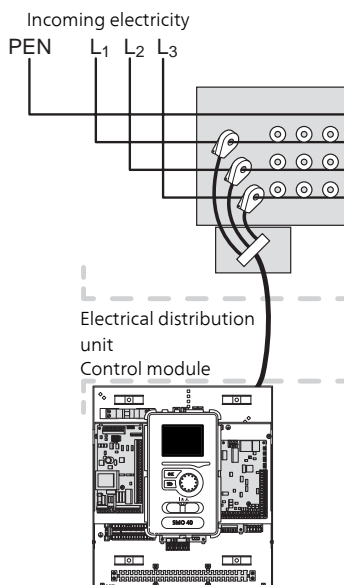

If the installed heat pump is frequency controlled, it will be limited when all power stages are disengaged.

## CONNECTING EXTERNAL ENERGY METER



### NOTE

Connection of external energy meter requires version 35 or later on input board (AA3) as well as "display version" 8762 or later.

One or two energy meters (BE6, BE7) are connected to terminal block X22 and/or X23 on input board (AA3).

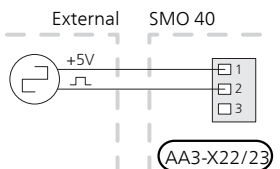
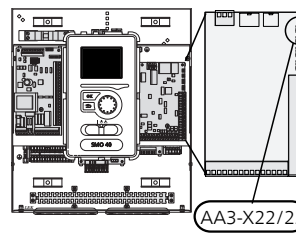

Activate the energy meter(s) in menu 5.2.4 and then set the desired value (energy per pulse) in menu 5.3.21.

## STEP CONTROLLED ADDITIONAL HEAT



### NOTE

Mark up any junction boxes with warnings for external voltage.

### Step-controlled additional heat before the reversing valve

External step-controlled additional heat can be controlled by up to three potential-free relays in the control module (3 step linear or 7 step binary).

The electric additional heat will charge with the maximum permitted immersion heater output together with the compressor to conclude the hot water charging and return to charging the heating as soon as possible. This only occurs when the number of degree minutes is below the start value for the additional heat.

## Step-controlled additional heat after the reversing valve

External step-controlled additional heat can be controlled by two relays (2 step linear or 3 step binary), which means that the third relay is used to control the immersion heater in the water heater/accumulator tank.

With the AXC 30 accessory, a further three potential-free relays can be used for additional heat control, which then gives an additional 3 linear or 7 binary steps.

Step in occurs with at least 1 minute interval and step outs with at least 3 seconds interval.

Step 1 is connected to terminal block X2:2 on the additional relay board (AA7).

Step 2 is connected to terminal block X2:4 on the additional relay board (AA7).

Step 3 or immersion heater in the water heater/accumulator tank is connected to terminal block X2:6 on the additional relay board (AA7).

The settings for step controlled additional heat are made in menu 4.9.3 and menu 5.1.12.

All additional heat can be blocked by connecting a potential-free switch function to the software-controlled input on terminal block X6 on the input board (AA3) or terminal block X2 (see page 31), which is selected in menu 5.4.

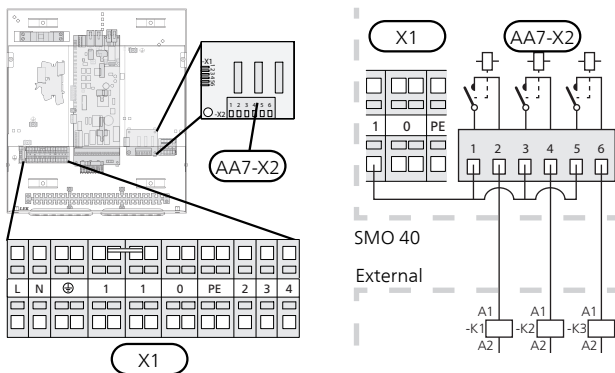

If the relays are to be used for control voltage, bridge the supply from terminal block X1:1 to X2:1, X2:3 and X2:5 on additional relay board (AA7). Connect the neutral from the external additional heat to terminal block X1:0.

## SHUNT CONTROLLED ADDITIONAL HEAT



### NOTE

Mark up any junction boxes with warnings for external voltage.

This connection enables an external additional heater, e.g. an oil boiler, gas boiler or district heating exchanger to aid with heating.

SMO 40 controls a shunt valve and start signal for the additional heat using three relays. If the installation cannot manage to maintain the correct supply temperature, the additional heat starts. When the boiler sensor (BT52) shows approx. 55 °C, SMO 40 sends a signal to the shunt (QN11) to open from the additional heat. The shunt (QN11) is controlled to ensure the true supply temperature corresponds with the control system's theoretically calculated set point value. When the heating demand drops sufficiently so that additional heat is no longer required, the shunt (QN11) closes completely. Factory-set minimum operating time for the boiler is 12 hours (can be adjusted in menu 5.1.12).

The settings for shunt controlled additional heat are made in menu 4.9.3 and menu 5.1.12.

The boiler sensor (BT52) is connected to soft inputs and selected in menu 5.4.

Connect the shunt motor (QN11) to terminal block X2:4 (230 V V, close) and 6 (230 V V, open) on the additional relay board (AA7) and terminal block X1:0 (N).

To control switching the additional heat on and off, connect it to terminal block X2:2 on the extra relay board (AA7).

All additional heat can be blocked by connecting a potential-free switch function to the software-controlled input on terminal block X6 on the input board (AA3), or terminal block X2 (see page 31), which is selected in menu 5.4.

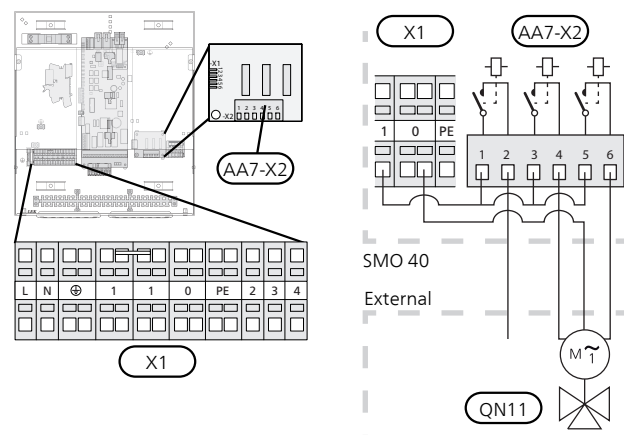

If the relays are to be used for control voltage, bridge the supply from terminal block X1:1 to X2:1, X2:3 and X2:5 on additional relay board (AA7).

## RELAY OUTPUT FOR EMERGENCY MODE



### NOTE

Mark up any junction boxes with warnings for external voltage.

When the switch (SF1) is in "⚠" mode (emergency mode) the following components are activated (if they are connected).

- the circulation pumps (EB101-GP12 and EB102-GP12)
- external circulation pump (GP10)
- the potential free switching emergency mode relay (K2).



### Caution

External accessories are disconnected.



### Caution

No hot water is produced when emergency mode is activated.

The emergency mode relay can be used to activate external additional heat, an external thermostat must then be connected to the control circuit to control the temperature. Ensure that the heating medium circulates through the external additional heating.

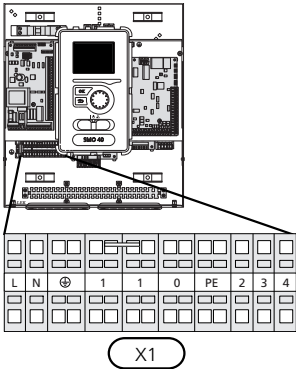

X1

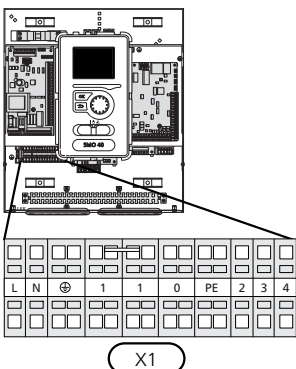

X1

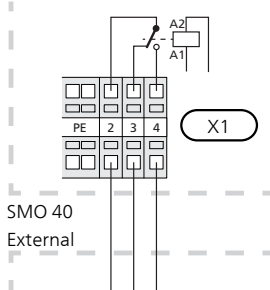

SMO 40  
External

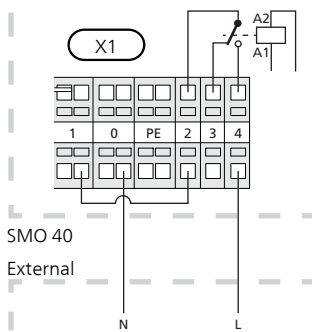

SMO 40  
External

If the relay is to be used for control voltage, bridge the supply from terminal block X1:1 to X1:2 and connect neutral and control voltage from the external additional heat to X1:0 (N) and X1:4 (L).

## EXTERNAL CIRCULATION PUMP

Connect the external circulation pump (GP10) to terminal block X4:9 (PE), X4:10 (N) and X4:11 (230 V) on the base board (AA2) as illustrated.

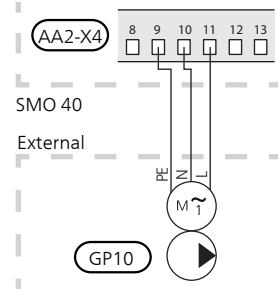
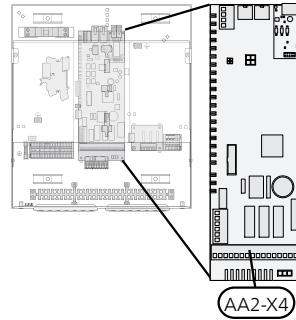

## SHUTTLE VALVE

SMO 40 can be supplemented with an external reversing valve (QN10) for hot water control. (See page 61 for accessory)

Hot water production can be selected in menu 5.2.4.

Connect the external reversing valve (QN10) as illustrated to terminal block X4:2 (N), X4:3 (control) and X4:4 (L) on the base board (AA2).

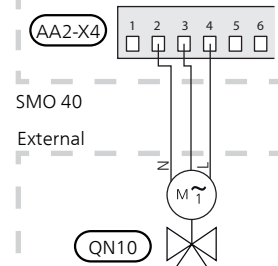
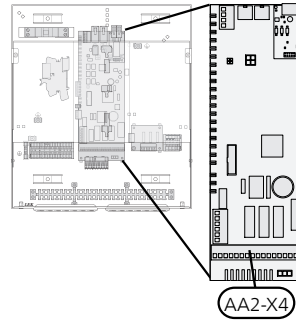

## NIBE UPLINK

Connect the network connected cable (straight, Cat.5e UTP) with RJ45 contact (male) to contact AA4-X9 on the display unit (as illustrated). Use the cable grommet (UB2) in the control module for cable routing.

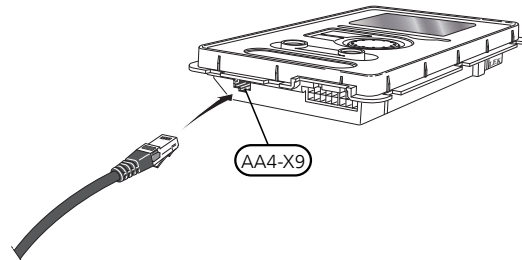

## EXTERNAL CONNECTION OPTIONS (AUX)

On the input board (AA3-X6) and terminal block (X2), SMO 40 has software-controlled AUX inputs and outputs for connecting the external switch function or sensor. This means that when an external switch function (the switch must be potential-free) or sensor is connected to one of the six special connections, this function for the connection must be selected in menu 5.4.

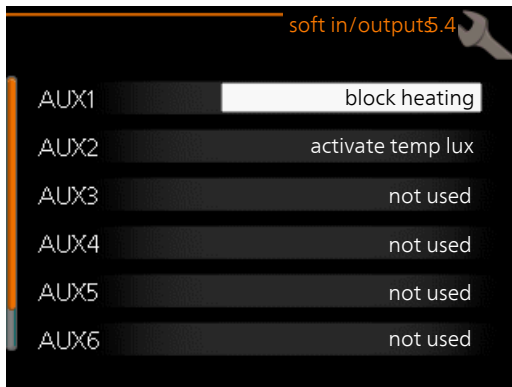

For certain functions, accessories may be required.

### Selectable inputs

Selectable inputs on the input board for these functions are:

AUX1	AA3-X6:9-10
AUX2	AA3-X6:11-12
AUX3	AA3-X6:13-14
AUX4	X2:1
AUX5	X2:2
AUX6	X2:3

GND for AUX4-6 is connected to terminal block X2:4.

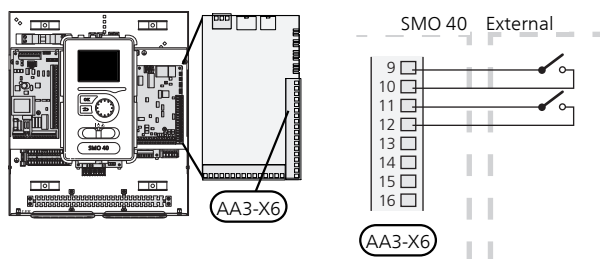

### Selectable output

A selectable output is AA3-X7.

**TIP**  
Some of the following functions can also be activated and scheduled via menu settings.

### Possible selection for AUX inputs

#### Temperature sensor

Temperature sensor can be connected to SMO 40. Use a 2-core cable of at least 0.5 mm<sup>2</sup> cable area.

Available options are:

- external supply temperature sensor cooling (EQ1-BT25) is used when docking 2-pipe cooling. (can be selected when the air/water heat pump is permitted to produce cooling)
- cooling/heating (BT74), determines when it is time to switch between cooling and heating mode (can be selected when the air/water heat pump is permitted to produce cooling)
- supply cooling (BT64) is used with active cooling 4-pipe (can be selected when the air/water heat pump is permitted to produce cooling)
- Boiler (BT52) (only shown if shunt-controlled additional heat is selected in menu 5.1.12)
- additional heat (BT63), is used when docking "step-controlled additional heat before reversing valve for hot water" in order to measure the temperature after the additional heat.

### Monitor

Available options are:

- alarm from external units. The alarm is connected to the control, which means that the malfunction is presented as an information message in the display. Potential-free signal of type NO or NC.
- stove monitor. (A thermostat that is connected to the chimney. When the negative pressure is too low and the thermostat is connected, the fans in ERS (NC) are closed.
- external level monitor for the condensate water drain (NO)

### External activation of functions

An external switch function can be connected to SMO 40 to activate various functions. The function is activated during the time the switch is closed.

Possible functions that can be activated:

- hot water comfort mode "temporary lux"
- hot water comfort mode "economy"
- "external adjustment"

To change the supply temperature and in doing so change the room temperature, an external switch function can be connected to SMO 40.

When the switch is closed, the temperature changes in °C (if the room sensor is connected and activated). If a room sensor is not connected or not activated, the desired change of "temperature" (heating curve offset) is set with the number of steps selected. The value is adjustable between -10 and +10. External adjustment of climate systems 2 to 8 requires accessories.

– climate system 1 to 8

The value for the change is set in menu 1.9.2, "external adjustment".

- activation of one of four fan speeds.  
(Can be selected if ventilation accessory is activated.)

The following five options are available:

- 1-4 is normally open (NO)
- 1 normally closed (NC)

The fan speed is activated during the time the switch is closed. Normal speed is resumed when the switch is opened again.

- SG ready



### Caution

This function can only be used in mains networks that support the "SG Ready" standard. "SG Ready" requires two AUX inputs.

In cases where this function is required, it must be connected to terminal block X6 on the input board (AA3) or to terminal block X2.

"SG Ready" is a smart form of tariff control, through which your electricity supplier can affect the indoor, hot water and/or pool temperatures (if applicable) or simply block the additional heat and/or compressor in the heat pump at certain times of the day (can be selected in menu 4.1.5 after the function is activated). Activate the function by connecting potential-free switch functions to two inputs selected in menu 5.4 (SG Ready A and SG Ready B).

Closed or open switch means one of the following:

- *Blocking (A: Closed, B: Open)*

"SG Ready" is active. The compressor in the heat pump and additional heat is blocked like the day's tariff blocking.

- *Normal mode (A: Open, B: Open)*

"SG Ready" is not active. No effect on the system.

- *Low price mode (A: Open, B: Closed)*

"SG Ready" is active. The system focuses on costs savings and can for example exploit a low tariff from the electricity supplier or over-capacity from any own power source (effect on the system can be adjusted in the menu 4.1.5).

- *Overcapacity mode (A: Closed, B: Closed)*

"SG Ready" is active. The system is permitted to run at full capacity at over capacity (very low price) with the electricity supplier (effect on the system is settable in menu 4.1.5).

(A = SG Ready A and B = SG Ready B)

- +Adjust

Using +Adjust, the installation communicates with the underfloor heating's control centre\* and adjusts the heating curve and calculated supply temperature according to the underfloor heating system's reconnection.

Activate the climate system you want +Adjust to affect by highlighting the function and pressing the OK button.

\*Support for +Adjust required



### Caution

This accessory may require a software update in your SMO 40. The version can be checked in the "Service info" menu 3.1. Visit [nibeuplink.com](http://nibeuplink.com) and click on the "Software" tab to download the latest software to your installation.



### Caution

In systems with both under floor heating and radiators, NIBE ECS 40/41 should be used for optimum operation.

### External blocking of functions

An external switch function can be connected to SMO 40 for blocking various functions. The switch must be potential-free and a closed switch results in blocking.



### NOTE

Blocking entails a risk of freezing.

Functions that can be blocked:

- hot water (hot water production). Any hot water circulation (HWC) remains in operation.
- heating/cooling (production and distribution)
- additional heat (additional heat is blocked)
- compressor in heat pump EB101 and/or EB102
- tariff blocking (additional heat, compressor, heating, cooling and hot water are disconnected)
- block OPT10 (Can be selected when the accessory OPT10 is activated.)
- block AZ10, blocks the compressor in F135. (Can be selected when the accessory F135 is activated.)

### Possible selections for AUX output

It is possible to have an external connection through the relay function via a potential-free switching relay (max. 2 A) on the input board (AA3), terminal block X7. The function must be activated in menu 5.4.

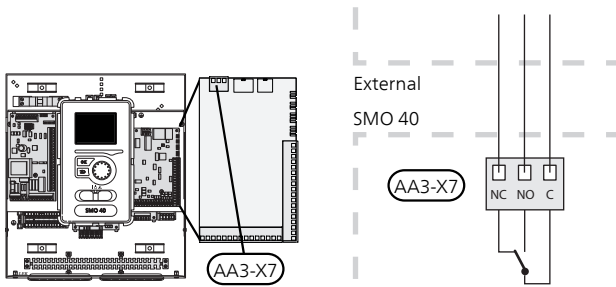

The picture shows the relay in the alarm position.

When switch (SF1) is in the "U" or "Δ" position the relay is in the alarm position.

**Caution**  
 The relay outputs may be subjected to a max load of 2 A at resistive load (230V AC).

**TIP**  
 The AXC accessory is required if more than one function is to be connected to the AUX output.

An external circulation pump is connected to the AUX output, as illustrated below.

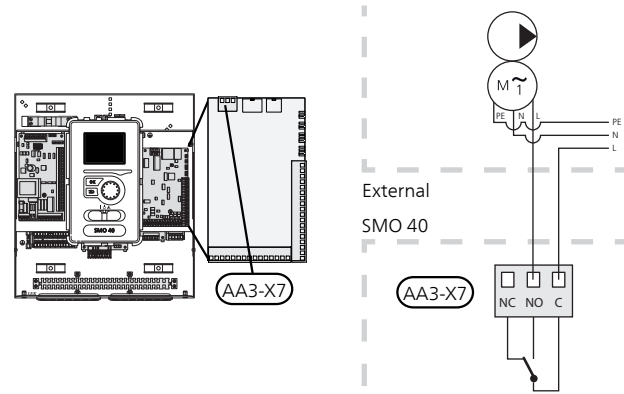

Optional functions for external connection:

*Indications*

- indication of common alarm
- cooling mode indication (can be selected when the air/water heat pump is permitted to produce cooling)
- holiday indication

*Control*

- control of circulation pump for hot water circulation
- control of active cooling in a 4-pipe system (can be selected when the air/water heat pump is permitted to run cooling)
- control of external circulation pump (for heating medium)
- photovoltaic control (Can be selected when the accessory EME 10/20 is activated.)  
 photovoltaic control (Can be selected when the accessory EME 20 is activated.)

*Activation*

- activation of away mode for "smart home" (complement to the functions in menu 4.1.7)

**NOTE**  
 The relevant distribution box must be marked with a warning about external voltage.



# Connecting accessories

Instructions for connecting other accessories are in the installation instructions provided. See page 61 for a list of those accessories that can be used for SMO 40.

## ACCESSORIES WITH ACCESSORY BOARD (AA5)

Accessories with accessory board (AA5) are connected to the control module's terminal block X4:4-6 on the input board AA5.

If several accessories are to be connected or are already installed, the following instructions must be followed.

The first accessory board must be connected directly to the control module's terminal block AA5-X4. The following boards must be connected in series with the previous board.

Use cable type LiYY, EKKX or similar.

Refer to the accessory manual for further instructions.

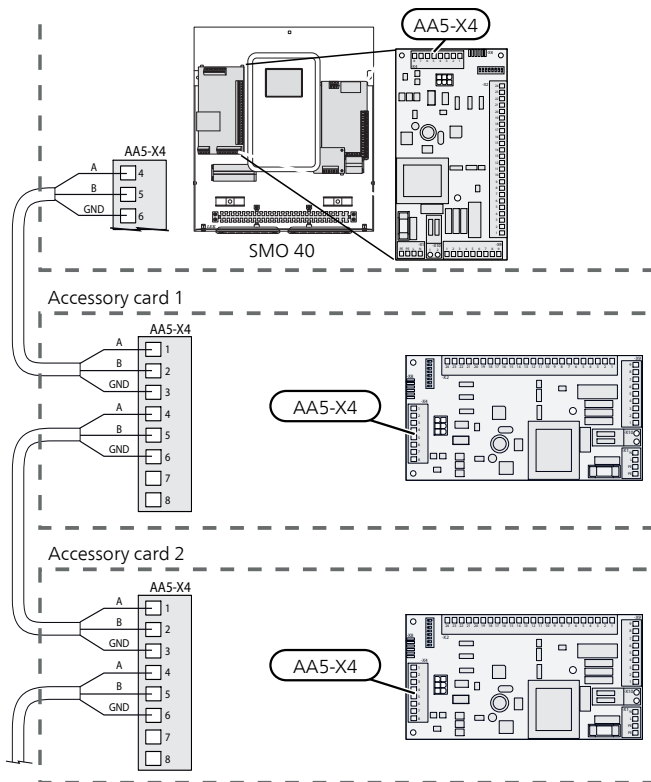

## ACCESSORIES WITH SMS BOARD (AA9)

Accessories with SMS board (AA9) are connected to the control module terminal block X4:9-12 on the input board AA3. Use cable type LiYY, EKKX or equivalent.

Refer to the accessory manual for further instructions.

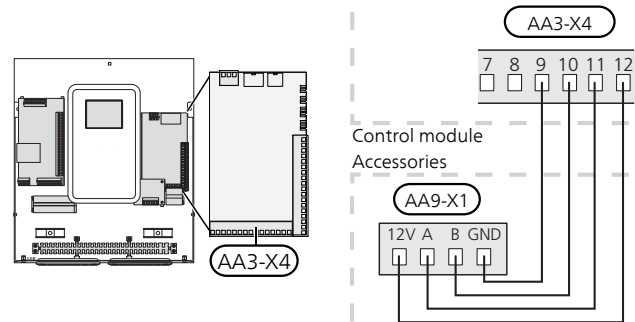

# 6 Commissioning and adjusting

## Preparations

- Compatible NIBE air/water heat pump must be equipped with a control board that, as a minimum, has the software version as listed on page 12. The control board's version is shown in the heat pump's display (if applicable) at start-up.
- SMO 40 must be ready-connected.
- The climate system must be filled with water and bled.

## Commissioning

### WITH NIBE AIR/WATER HEAT PUMP

Follow the instructions in the heat pump's Installer Manual under section "Commissioning and adjustment" – "Start-up and inspection".

### SMO 40

1. Power the heat pump.
2. Power SMO 40.
3. Follow the start guide in the display on SMO 40 alternatively start the start guide in menu 5.7.

## Commissioning with additional heating only

At first start follow the start guide, otherwise follow the list below.

1. Configure the additional heat in menu 5.1.12.
2. Go to menu 4.2 op. mode.
3. Mark "add. heat only" using the control knob and then press the OK button.
4. Return to the main menus by pressing the Back button.



### Caution

When commissioning without NIBE air/water heat pump an alarm communication error may appear in the display.

The alarm is reset if the relevant air/water heat pump is deactivated in menu 5.2.2 ("installed slaves").

## Check the reversing valve

1. Activate "AA2-K1 (QN10)" in menu 5.6.
2. Check that the reversing valve opens or is open for hot water charging.
3. Deactivate "AA2-K1 (QN10)" in menu 5.6.

## Check AUX socket

To check any function connected to the AUX socket

1. Activate "AA3-X7" in menu 5.6.
2. Check the desired function.
3. Deactivate "AA3-X7" in menu 5.6.

## Cooling mode

If the installation contains one or more NIBE air/water heat pumps that can produce cooling (NIBE F2040 or F2120) cooling operation can be permitted. See relevant Installer Manual.

When cooling operation is permitted you can choose cooling mode indication in menu 5.4 for the AUX output.

# Start-up and inspection

## START GUIDE



### NOTE

There must be water in the climate system before the switch is set to "I".

1. Set switch (SF1) on SMO 40 to position "I".
2. Follow the instructions in the display's start guide. If the start guide does not start when you start the SMO 40, start it manually in menu 5.7.



### TIP

See the section "Control – Introduction" for a more detailed introduction to the installation's control system (operation, menus, etc.).

## Commissioning

The first time the installation is started a start guide is started. The start guide instructions state what needs to be carried out at the first start together with a run through of the installation's basic settings.

The start guide ensures that start-up is carried out correctly and cannot be bypassed. The start guide can be started later in menu 5.7.

During the start-up guide, the reversing valves and the shunt are run back and forth to help vent the heat pump.



### Caution

As long as the start guide is active, no function in SMO 40 will start automatically.

The start guide will appear at each restart of SMO 40, until it is deselected on the last page.

## Operation in the start guide

A. Page

B. Name and menu number

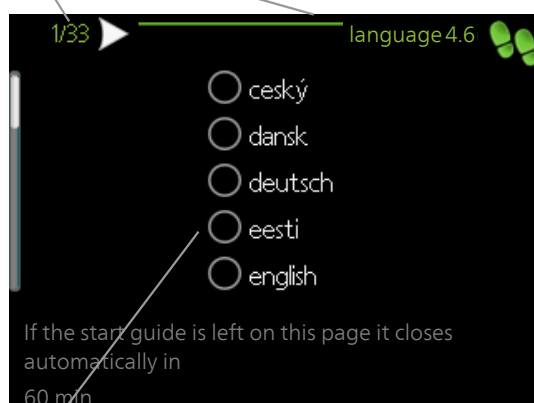

C. Option / setting

### A. Page

Here you can see how far you have come in the start guide.

Scroll between the pages of the start guide as follows:

1. Turn the control knob until one of the arrows in the top left corner (at the page number) has been marked.
2. Press the OK button to skip between the pages in the start guide.

### B. Name and menu number

Here, you can see which menu in the control system this page of the start guide is based on. The digits in brackets refer to the menu number in the control system.

If you want to read more about affected menus either consult the help menu or read the user manual.

### C. Option / setting

Make settings for the system here.

### D. Help menu



In many menus there is a symbol that indicates that extra help is available.

To access the help text:

1. Use the control knob to select the help symbol.
2. Press the OK button.

The help text often consists of several windows that you can scroll between using the control knob.

# 7 Control - Introduction

## Display unit

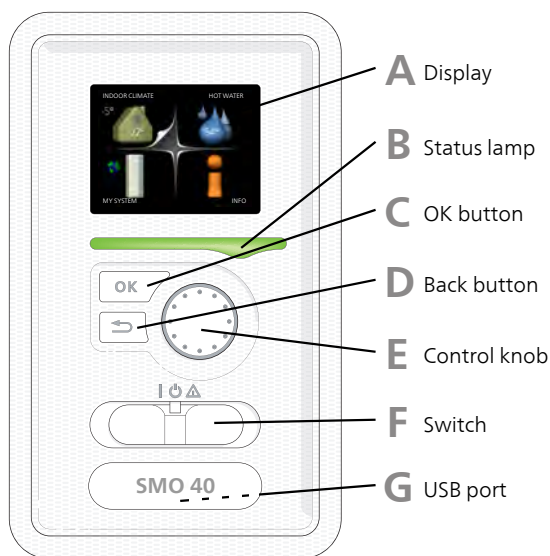

### A DISPLAY

Instructions, settings and operational information are shown on the display. You can easily navigate between the different menus and options to set the comfort or obtain the information you require.

### B STATUS LAMP

The status lamp indicates the status of the control module. It:

- lights green during normal operation.
- lights yellow in emergency mode.
- lights red in the event of a deployed alarm.

### C OK BUTTON

The OK button is used to:

- confirm selections of sub menus/options/set values/page in the start guide.

### D BACK BUTTON

The back button is used to:

- go back to the previous menu.
- change a setting that has not been confirmed.

### E CONTROL KNOB

The control knob can be turned to the right or left. You can:

- scroll in menus and between options.
- increase and decrease the values.
- change page in multiple page instructions (for example help text and service info).

### F SWITCH (SF1)

The switch assumes three positions:

- On (I)
- Standby (⏻)
- Emergency mode (⚠)

The emergency mode must only be used in the event of a fault in the control module. In this mode, the compressor in the heat pump switches off and any immersion heater engages. The control module display is not lit and the status lamp shines yellow.

### G USB PORT

The USB port is hidden beneath the plastic badge with the product name on it.

The USB port is used to update the software.

Visit [nibeuplink.com](http://nibeuplink.com) and click the "Software" tab to download the latest software for your installation.

# Menu system

When the door to the control module is opened, the menu system's four main menus are shown in the display as well as certain basic information.

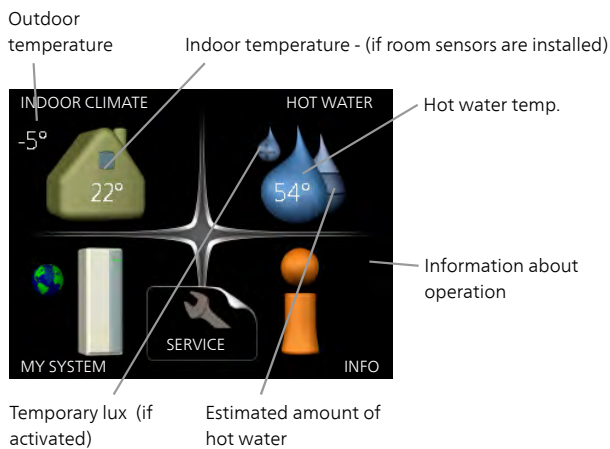

## MENU 1 - INDOOR CLIMATE

Setting and scheduling the indoor climate. See information in the help menu or user manual.

## MENU 2 - HOT WATER

Setting and scheduling hot water production. See information in the help menu or user manual.

This menu only appears if a water heater is installed in the system.

## MENU 3 - INFO

Display of temperature and other operating information and access to the alarm log. See information in the help menu or user manual.

## MENU 4 - MY SYSTEM

Setting time, date, language, display, operating mode etc. See information in the help menu or user manual.

## MENU 5 - SERVICE

Advanced settings. These settings are not available to the end user. The menu is visible when the Back button is pressed for 7 seconds, when you are in the start menu. See page 43.

## SYMBOLS IN THE DISPLAY

The following symbols can appear in the display during operation.

Symbol	Description
	This symbol appears by the information sign if there is information in menu 3.1 that you should note.
	These two symbols indicate if the compressor in the outdoor module or the additional heat in the installation is blocked via SMO 40. These can, for example, be blocked depending on which operating mode is selected in menu 4.2, if blocking is scheduled in menu 4.9.5 or if an alarm has occurred that blocks one of them. Blocking the compressor. Blocking additional heat.
	This symbol appears if periodic increase or lux mode for the hot water is activated.
	This symbol indicates whether "holiday setting" is active in 4.7.
	This symbol indicates whether SMO 40 has contact with NIBE Uplink.
	This symbol indicates the actual speed of the fan if the speed has changed from the normal setting. Accessory needed.
	This symbol is visible in installations with active solar accessories.
	This symbol indicates whether pool heating is active. Accessory needed.
	This symbol indicates whether cooling is active. Heat pump with cooling function required.

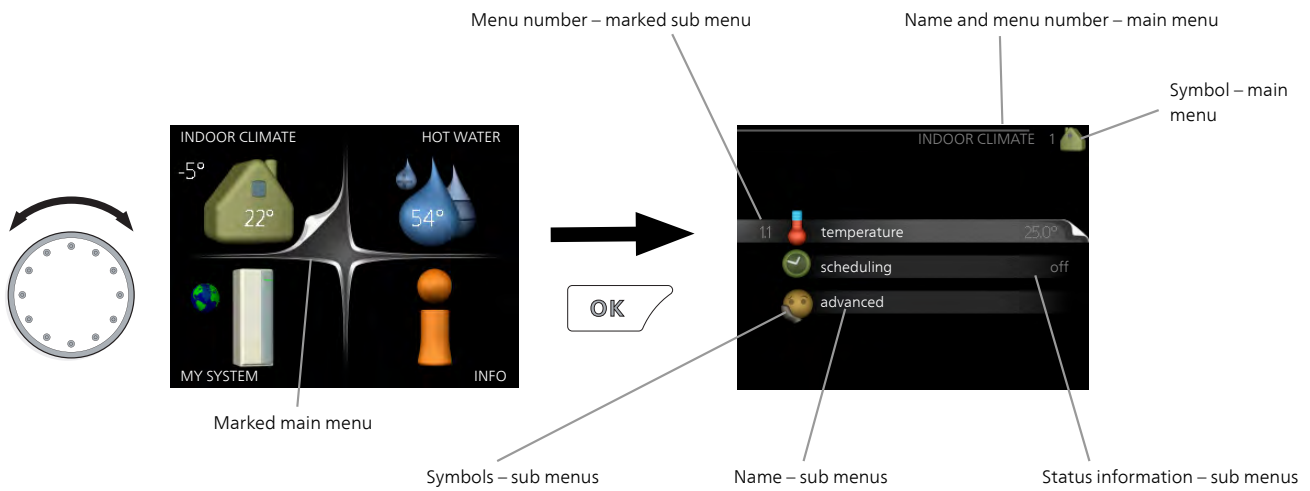

## OPERATION

To move the cursor, turn the control knob to the left or the right. The marked position is white and/or has a turned up tab.



## SELECTING MENU

To advance in the menu system select a main menu by marking it and then pressing the OK button. A new window then opens with sub menus.

Select one of the sub menus by marking it and then pressing the OK button.



## SELECTING OPTIONS



In an options menu the current selected option is indicated by a green tick.



To select another option:

1. Mark the applicable option. One of the options is pre-selected (white). 
2. Press the OK button to confirm the selected option. The selected option has a green tick. 

## SETTING A VALUE



Values to be changed

To set a value:

1. Mark the value you want to set using the control knob. 01
2. Press the OK button. The background of the value becomes green, which means that you have accessed the setting mode. 01
3. Turn the control knob to the right to increase the value and to the left to reduce the value. 04
4. Press the OK button to confirm the value you have set. To change and return to the original value, press the Back button. 04

## USE THE VIRTUAL KEYBOARD

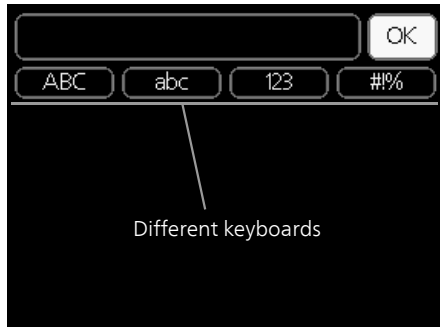

In some menus where text may require entering, a virtual keyboard is available.



Depending on the menu, you can gain access to different character sets which you can select using the control knob. To change character table, press the Back button. If a menu only has one character set the keyboard is displayed directly.

When you have finished writing, mark "OK" and press the OK button.

## SCROLL THROUGH THE WINDOWS

A menu can consist of several windows. Turn the control knob to scroll between the windows.



Current menu window      Number of windows in the menu

### *Scroll through the windows in the start guide*



Arrows to scroll through window in start guide

1. Turn the control knob until one of the arrows in the top left corner (at the page number) has been marked.
2. Press the OK button to skip between the steps in the start guide.

## HELP MENU



In many menus there is a symbol that indicates that extra help is available.

To access the help text:

1. Use the control knob to select the help symbol.
2. Press the OK button.

The help text often consists of several windows that you can scroll between using the control knob.

# 8 Control

## Menu 1 - INDOOR CLIMATE

1 - INDOOR CLIMATE	1.1 - temperature	1.1.1 - heating			
		1.1.2 - cooling **			
	1.2 - ventilation *				
	1.3 - scheduling	1.3.1 - heating			
		1.3.2 - cooling **			
		1.3.3 - ventilation *			
	1.9 - advanced	1.9.1 - curve	1.9.1.1 heating curve		
			1.9.1.2 - cooling curve **		
		1.9.2 - external adjustment			
		1.9.3 - min. flow line temp.	1.9.3.1 - heating		
			1.9.3.2 - cooling **		
		1.9.4 - room sensor settings			
		1.9.5 - cooling settings *			
		1.9.6 - fan return time *			
1.9.7 - own curve		1.9.7.1 - heating			
		1.9.7.2 - cooling **			
1.9.8 - point offset					
1.9.9 - night cooling*					

\* Accessories are needed.

\*\* Heat pump with cooling function required.



# Menu 2 - HOT WATER

2 - HOT WATER\*

2.1 - temporary lux

2.2 - comfort mode

2.3 - scheduling

2.9 - advanced

2.9.1 - periodic increase

2.9.2 - hot water recirc. \*

# Menu 3 - INFO

3 - INFO

3.1 - service info

3.2 - compressor info

3.3 - add. heat info

3.4 - alarm log

3.5 - indoor temp. log

\* Accessories are needed.

# Menu 4 - MY SYSTEM

4 - MY SYSTEM	4.1 - plus functions	4.1.1 - pool *
		4.1.2 - pool 2 *
		4.1.3 - internet
		4.1.3.1 - NIBE Uplink
		4.1.3.8 - tcp/ip settings
		4.1.3.9 - proxy settings
		4.1.4 - sms *
		4.1.5 - SG Ready
		4.1.6 - smart price adaption™
		4.1.7 - smart home
		4.1.8 - smart energy source™
		4.1.8.1 - settings
		4.1.8.2 - set. price
		4.1.8.3 - CO2 impact
		4.1.8.4 - tariff periods, electricity
		4.1.8.6 - tariff per, ext. shunt add
		4.1.8.7 - tariff per, ext. step add
		4.1.8.8 - tariff periods, OPT10*
		Menu 4.1.10 – solar electricity *
	4.2 - op. mode	
	4.3 - my icons	
	4.4 - time & date	
	4.6 - language	
	4.7 - holiday setting	
	4.9 - advanced	4.9.1 - op. prioritisation
		4.9.2 - auto mode setting
		4.9.3 - degree minute setting
		4.9.4 - factory setting user
		4.9.5 - schedule blocking
		4.9.6 - schedule silent mode
		4.9.7 – tools

\* Accessories are needed.

# Menu 5 - SERVICE

## OVERVIEW

5 - SERVICE	5.1 - operating settings	5.1.1 - hot water settings *	
		5.1.2 - max flow line temperature	
		5.1.3 - max diff flow line temp.	
		5.1.4 - alarm actions	
		5.1.5 - fan sp. exhaust air *	
		5.1.6 - fan sp. supply air*	
		5.1.12 - addition	
		5.1.14 - flow set. climate system	
		5.1.22 - heat pump testing	
		5.1.23 - compressor curve	
		5.1.25 - time filter alarm*	
	5.2 - system settings	5.2.2 - installed slaves	
		5.2.3 - docking	
		5.2.4 - accessories	
	5.3 - accessory settings	5.3.2 - shunt controlled add. heat *	
		5.3.3 - extra climate system *	
		5.3.4 - solar heating *	
		5.3.6 - step controlled add. heat	
		5.3.8 - hot water comfort *	
		5.3.11 - modbus *	
		5.3.12 - exhaust/supply air module *	
		5.3.14 - F135 *	
		5.3.15 - GBM communications module *	
		5.3.16 - humidity sensor *	
		5.3.21 - flow sensor / energy meter	
	5.4 - soft in/outputs		
	5.5 - factory setting service		
	5.6 - forced control		
	5.7 - start guide		
	5.8 - quick start		
	5.9 - floor drying function		
	5.10 - change log		
	5.11 - slave settings	5.11.1 - EB101	5.11.1.1 - heat pump
			5.11.1.2 - charge pump (GP12)
		5.11.2 - EB102	
		5.11.3 - EB103	
		5.11.4 - EB104	
		5.11.5 - EB105	
		5.11.6 - EB106	
		5.11.7 - EB107	
		5.11.8 - EB108	
	5.12 - country		

\* Accessory needed.

Go to the main menu and hold the Back button in for 7 seconds to access the Service menu.

### Sub-menus

Menu **SERVICE** has orange text and is intended for the advanced user. This menu has several sub-menus. Status information for the relevant menu can be found on the display to the right of the menus.

**operating settings** Operating settings for the control module.

**system settings** System settings for the control module, activating accessories etc.

**accessory settings** Operational settings for different accessories.

**soft in/outputs** Setting software controlled in and outputs on the input card (AA3) and terminal block (X2).

**factory setting service** Total reset of all settings (including settings available to the user ) to default values.

**forced control** Forced control of the different components in the indoor module.

**start guide** Manual start of the start guide which is run the first time when the control module is started.

**quick start** Quick starting the compressor.



#### NOTE

Incorrect settings in the service menus can damage the installation.

## MENU 5.1 - OPERATING SETTINGS

Operating settings can be made for the control module in the sub menus.

### MENU 5.1.1 - HOT WATER SETTINGS

The hot water settings require that hot water production is activated in menu 5.2.4 accessories.

#### *economy*

Setting range start temp. economy: 5 – 55 °C

Factory setting start temp. economy: 42 °C

Setting range stop temp. economy: 5 – 60 °C

Factory setting stop temp. economy: 48 °C

#### *normal*

Setting range start temp. normal: 5 – 60 °C

Factory setting start temp. normal: 46 °C

Setting range stop temp. normal: 5 – 65 °C

Factory setting stop temp. normal: 50 °C

#### *luxury*

Setting range start temp. lux: 5 – 70 °C

Factory setting start temp. lux: 49 °C

Setting range stop temp. lux: 5 – 70 °C

Factory setting stop temp. lux: 53 °C

#### *stop temp. per. increase*

Setting range: 55 – 70 °C

Factory setting: 55 °C

#### *step difference compressors*

Setting range: 0.5 – 4.0 °C

Factory setting: 1.0 °C

#### *charge method*

Setting range: target temp, delta temp

Default value: delta temp

Here you set the start and stop temperature of the hot water for the different comfort options in menu 2.2 as well as the stop temperature for periodic increase in menu 2.9.1.

The charge method for hot water operation is selected here. "delta temp" is recommended for heaters with charge coil, "target temp" for double-jacketed heaters and heaters with hot water coil.

## MENU 5.1.2 - MAX FLOW LINE TEMPERATURE

### *climate system*

Setting range: 5-80 °C

Default value: 60 °C

Set the maximum supply temperature for the climate system here. If the installation has more than one climate system, individual maximum supply temperatures can be set for each system. Climate systems 2 - 8 cannot be set to a higher max supply temperature than climate system 1.



#### Caution

Underfloor heating systems are normally **max flow line temperature** set between 35 and 45 °C.

Check the max floor temperature with your floor supplier.

## MENU 5.1.3 - MAX DIFF FLOW LINE TEMP.

### *max diff compressor*

Setting range: 1 – 25 °C

Default value: 10 °C

### *max diff addition*

Setting range: 1 – 24 °C

Default value: 7 °C

Here you set the maximum permitted difference between the calculated and actual supply temperature during compressor respectively add. heat mode. Max diff. additional heat can never exceed max diff. compressor

### *max diff compressor*

If the current supply temperature *exceeds* the calculated supply by set value, the degree minute value is set to +2. The compressor in the heat pump stops if there is only a heating demand.

### *max diff addition*

If "addition" is selected and activated in menu 4.2 and the current supply temperature *exceeds* the calculated temperature by the set value, the additional heat is forced to stop.

## MENU 5.1.4 - ALARM ACTIONS

Select how you want the control module to alert you that there is an alarm in the display here. The different alternatives are; the heat pump stops producing hot water and/or reduces the room temperature.



### *Caution*

If no alarm action is selected, it can result in higher energy consumption in the event of an alarm.

## MENU 5.1.5 - FAN SP. EXHAUST AIR (ACCESSORY IS REQUIRED)

### *normal and speed 1-4*

Setting range: 0 – 100 %

Set the speed for the five different selectable speeds for the fan here.



### *Caution*

An incorrectly set ventilation flow can damage the house and may also increase energy consumption.

## MENU 5.1.6 - FAN SP. SUPPLY AIR (ACCESSORY REQUIRED)

### *normal and speed 1-4*

Setting range: 0 – 100 %

Set the speed for the five different selectable speeds for the fan here.



### *Caution*

An incorrectly set value may damage the house in the long term and possibly increase energy consumption.

## MENU 5.1.12 - ADDITION

Make settings for connected additional heat (step controlled or shunt controlled additional heat) here.

Select whether step controlled or shunt controlled additional heat is connected. Then you can make settings for the different alternatives.

### *add.type: step controlled*

#### *max step*

Setting range (binary stepping deactivated): 0 – 3

Setting range (binary stepping activated): 0 – 7

Default value: 3

#### *fuse size*

Setting range: 1 - 200 A

Factory setting: 16 A

#### *transformation ratio*

Setting range: 300 - 3000

Factory setting: 300

Select this option if the step controlled additional heat is connected and is positioned before or after the reversing valve for hot water charging (QN10). Step controlled additional heat is for example an external electric boiler.

When binary stepping is deactivated (off), the settings refer to linear stepping.

Here, you can set the maximum number of permitted additional heat steps, whether there is internal additional heat in the tank (only accessible if the additional heat is positioned after the reversing valve for hot water charging (QN10)), whether binary stepping is to be used, the size of the fuse and the transformer ratio.



### *TIP*

In order to select location before or after QN10, you need to tick "hot water production" in menu 5.2.4 - accessories and add a docking in menu 5.2.3 - docking. (Only one air/water heat pump in the system applies for this option.)

*add.type: shunt controlled*

*prioritised additional heat*

Setting range: on/off

Factory setting: off

*minimum running time*

Setting range: 0 – 48 h

Default value: 12 h

*min temp.*

Setting range: 5 – 90 °C

Default value: 55 °C

*mixing valve amplifier*

Setting range: 0.1 –10.0

Default value: 1.0

*mixing valve step delay*

Setting range: 10 – 300 s

Default values: 30 s

*fuse size*

Setting range: 1 - 200 A

Factory setting: 16 A

*transformation ratio*

Setting range: 300 - 3000

Factory setting: 300

Select this option if shunt controlled additional heat is connected.

Set when the addition is to start, the minimum run time and the minimum temperature for external addition with shunt here. External addition with shunt is for example a wood/oil/gas/pellet boiler.

You can set shunt valve amplification and shunt valve waiting time.

Selecting "prioritised additional heat" uses the heat from the external additional heat instead of the heat pump. The shunt valve is regulated as long as heat is available, otherwise the shunt valve is closed.

## MENU 5.1.14 - FLOW SET. CLIMATE SYSTEM

*presettings*

Setting range: radiator, floor heat., rad. + floor heat., DOT °C

Default value: radiator

Setting range DOT: -40.0 – 20.0 °C

The factory setting of DOT value depends on the country that has been given for the product's location. The example below refers to Sweden.

Factory setting DOT: -20.0 °C

*own setting*

Setting range dT at DOT: 0.0 – 25.0

Factory setting dT at DOT: 10.0

Setting range DOT: -40.0 – 20.0 °C

Factory setting DOT: -20.0 °C

The type of heating distribution system the heating medium pump works towards is set here.

dT at DOT is the difference in degrees between flow and return temperatures at dimensioned outdoor temperature.

## MENU 5.1.22 - HEAT PUMP TESTING



### NOTE

This menu is intended for testing SMO 40 according to different standards.

Use of this menu for other reasons may result in your installation not functioning as intended.

This menu contains several sub-menus, one for each standard.

## MENU 5.1.23 - COMPRESSOR CURVE



### Caution

This menu is only displayed if SMO 40 is connected to a heat pump with inverter controlled compressor.

Set whether the compressor in the heat pump should work to a particular curve under specific requirements or if it should work to predefined curves.

You set a curve for a demand (heat, hot water etc.) by unticking "auto", turning the control knob until a temperature is marked and pressing OK. You can now set at what temperatures the max. and min. frequencies, respectively will occur.

This menu can consist of several windows (one for each available demand), use the navigation arrows in the top left corner to change between the windows.

## MENU 5.1.25 - TIME FILTER ALARM

*months btwn filter alarms*

Setting range: 1 – 24

Factory setting: 3

Here you set the number of months between alarms for a reminder to clean the filter in a connected accessory.

## MENU 5.2 - SYSTEM SETTINGS

Make different system settings for your installation here, e.g. activate connected slaves and which accessories are installed.

### MENU 5.2.2 - INSTALLED SLAVES

If one or more air/water heat pumps are connected to the control module, you set it here.

There are two ways of activating connected slaves. You can either mark the alternative in the list or use the automatic function "search installed slaves".

*search installed slaves*

Mark "search installed slaves" and press the OK button to automatically find connected slaves for the master heat pump.

### MENU 5.2.3 - DOCKING

Enter how your system is docked regarding pipes, for example to pool heating, hot water heating and heating the building.

This menu has a docking memory which means that the control system remembers how a particular reversing valve is docked and automatically enters the correct docking the next time you use the same reversing valve.

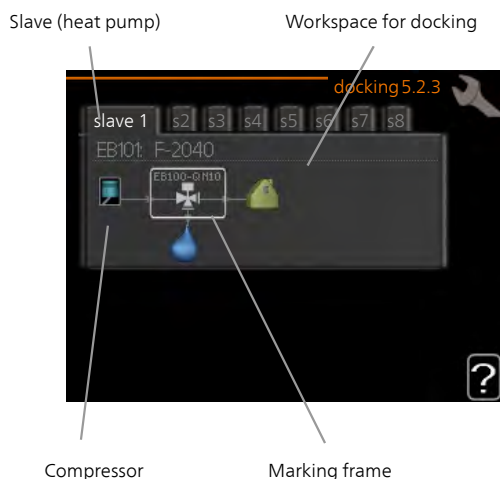

*Slave:* Here you select the heat pump for which the docking setting is to be adjusted.

*Compressor:* Here, you select whether the compressor in the heat pump is blocked (factory setting) or standard (docked, for example, to pool heating, hot water charging and heating the building).

*Marking frame:* Move around the marking frame using the control knob. Use the OK button to select what you want to change and to confirm the setting in the options box that appears to the right.

*Workspace for docking:* The system docking is drawn here.

Symbol	Description
	Compressor (blocked)
	Compressor (standard)
	Reversing valves for hot water, cooling respectively pool control. The designations above the reversing valve indicate where it is electrically connected (EB101 = Slave 1, CL11 = Pool 1 etc.).
	Hot water charging
	Pool 1
	Pool 2
	Heating (heating the building, includes any extra climate system)
	Cooling

### MENU 5.2.4 - ACCESSORIES

Set which accessories are installed on the installation here.

If the water heater is connected to SMO 40 hot water charging must be activated here.

There are two ways of activating connected accessories. You can either mark the alternative in the list or use the automatic function "search installed acc.".

*search installed acc.*

Mark "search installed acc." and press the OK button to automatically find connected accessories for SMO 40.

### MENU 5.3 - ACCESSORY SETTINGS

The operating settings for accessories that are installed and activated are made in the sub-menus for this.

## MENU 5.3.2 - SHUNT CONTROLLED ADD. HEAT

### *prioritised additional heat*

Setting range: on/off

Factory setting: off

### *start diff additional heat*

Setting range: 0 – 2000 DM

Default values: 400 DM

### *minimum running time*

Setting range: 0 – 48 h

Default value: 12 h

### *min temp.*

Setting range: 5 – 90 °C

Default value: 55 °C

### *mixing valve amplifier*

Setting range: 0.1 –10.0

Default value: 1.0

### *mixing valve step delay*

Setting range: 10 – 300 s

Default values: 30 s

Set when the addition is to start, the minimum run time and the minimum temperature for external addition with shunt here. External addition with shunt is for example a wood/oil/gas/pellet boiler.

You can set shunt valve amplification and shunt valve waiting time.

Selecting "prioritised additional heat" uses the heat from the external additional heat instead of the heat pump. The shunt valve is regulated as long as heat is available, otherwise the shunt valve is closed.



### *TIP*

See the accessory installation instructions for function description.

## MENU 5.3.3 - EXTRA CLIMATE SYSTEM

### *use in heating mode*

Setting range: on/off

Factory setting: on

### *use in cooling mode*

Setting range: on/off

Factory setting: off

### *mixing valve amplifier*

Setting range: 0.1 – 10.0

Default value: 1.0

### *mixing valve step delay*

Setting range: 10 – 300 s

Default values: 30 s

### *Controlled pump GP10*

Setting range: on/off

Factory setting: off

Here you select which climate system (2 - 8) you wish to set. In the next menu, you can make settings for the climate system that you have selected.

If the heat pump is connected to more than one climate system, condensation may occur in these, if they are not intended for cooling.

To prevent condensation, make sure that "use in heating mode" is checked for the climate systems that are not intended for cooling. This means that the sub-shunts to the extra climate systems close when cooling operation is activated.



### *Caution*

This setting option only appears if the heat pump is activated for cooling operation.

The shunt amplification and shunt waiting time for the different extra climate systems that are installed are also set here.

Activation/deactivation of "Controlled pump GP10" does not affect "extra climate system" because the accessory's circulation pump is controlled manually.

There is the option to set a speed on the accessory's circulation pump GP10.

See the accessory installation instructions for function description.



## MENU 5.3.4 - SOLAR HEATING

### *start delta-T GP4*

Setting range: 1 – 40 °C

Default value: 8 °C

### *stop delta-T GP4*

Setting range: 0 – 40 °C

Default value: 4 °C

### *max. tank temperature*

Setting range: 5 – 110 °C

Default value: 95 °C

### *max. solar collector temp.*

Setting range: 80 – 200 °C

Default value: 125 °C

### *anti-freeze temperature*

Setting range: -20 – +20 °C

Default value: 2 °C

### *start solar collector cooling*

Setting range: 80 – 200 °C

Default value: 110 °C

*start delta-T, stop delta-T:* Here, you can set the temperature difference between solar panel and solar tank at which the circulation pump will start and stop.

*max. tank temperature, max. solar collector temp.:* Here, you can set the maximum temperatures in the tank and solar panel respectively at which the circulation pump will stop. This is to protect against excess temperatures in the solar tank.

If the unit has an anti-freeze function and/or solar panel cooling you can activate them here. When the function has been activated, you can make settings for them.

### *freeze protection*

*anti-freeze temperature:* Here, you can set the temperature in the solar panel at which the circulation pump is to start to prevent freezing.

### *solar panel cooling*

*start solar collector cooling:* If the temperature in the solar panel is higher than this setting, at the same time as the temperature in the solar tank is higher than the set maximum temperature, the external function for cooling is activated.

See the accessory installation instructions for function description.

## MENU 5.3.6 - STEP CONTROLLED ADD. HEAT

### *start diff additional heat*

Setting range: 0 – 2000 DM

Default values: 400 DM

### *diff. between additional steps*

Setting range: 0 – 1000 DM

Default values: 30 DM

### *max step*

Setting range

(binary stepping deactivated): 0 – 3

Setting range

(binary stepping activated): 0 – 7

Default value: 3

### *binary stepping*

Setting range: on/off

Factory setting: off

Make settings for step controlled addition here. Step controlled addition is for example an external electric boiler.

It is possible, for example, to select when the additional heat is to start, to set the maximum number of permitted steps and whether binary stepping is to be used.

When binary stepping is deactivated (off), the settings refer to linear stepping.

See the accessory installation instructions for function description.

## MENU 5.3.8 - HOT WATER COMFORT

### *activating imm heater*

Setting range: on/off

Factory setting: off

### *activ. imm heat in heat mode*

Setting range: on/off

Factory setting: off

### *activating the mixing valve*

Setting range: on/off

Factory setting: off

### *outgoing hot water*

Setting range: 40 - 65 °C

Default value: 55 °C

### *mixing valve amplifier*

Setting range: 0.1 – 10.0

Default value: 1.0

### *mixing valve step delay*

Setting range: 10 – 300 s

Default values: 30 s

Make settings for the hot water comfort here.

See the accessory installation instructions for function description.

*activating imm heater*: The immersion heater is activated here, if installed in the water heater.

*activ. imm heat in heat mode*: Activate here whether the immersion heater in the tank (requires the above alternative to be activated) is to be permitted to charge hot water, if the compressors in the heat pump are prioritising heating.

*activating the mixing valve*: Activated if mixer valve is installed and it is to be controlled from SMO 40. When the option is active, you can set the outgoing hot water temperature, shunt amplification and shunt waiting time for the mixer valve.

*outgoing hot water*: Here, you can set the temperature at which the mixer valve is to restrict hot water from the water heater.

## MENU 5.3.11 - MODBUS

### *address*

Factory setting: address 1

### *word swap*

Factory setting: not activated

As from Modbus 40 version 10, the address can be set between 1 - 247. Earlier versions have a fixed address (address 1).

If you select "word swap", you will get "word swap" instead of the preset standard "big endian".

See the accessory installation instructions for function description.

## MENY 5.3.12 - EXHAUST/SUPPLY AIR MODULE

### *months btwn filter alarms*

Setting range: 1 – 24

Default value: 3

### *lowest extract air temp.*

Setting range: 0 – 10 °C

Default value: 5 °C

### *bypass at excess temperature*

Setting range: 2 – 10 °C

Default value: 4 °C

### *bypass during heating*

Setting range: on/off

Factory setting: off

### *cut-out value, exh. air temp.*

Setting range: 5 – 30 °C

Default value: 25 °C

### *max. fan speed*

Setting range: 0 – 100%

Factory setting: 75 %

### *min. fan speed*

Setting range: 0 – 100%

Factory setting: 60 %

### *control sensor 1 (HTS)*

Setting range: 1 – 4

Default value: 1

*months btwn filter alarms*: Set how often the filter alarm is to be displayed.

*lowest extract air temp.*: Set the minimum extract air temperature to prevent the heat exchanger freezing.

*bypass at excess temperature*: If a room sensor is installed, set the excess temperature at which the bypass damper is to open here.



### TIP

See the installation instructions for ERS and HTS for a function description.

## MENU 5.3.14 - F135

### *charge pump speed*

Setting range: 1 – 100 %

Factory setting: 70 %

### *hot water at cooling*

Setting range: on/off

Factory setting: off

Here you can set the charge pump speed for F135. You can also choose whether you want to be able to charge hot water with F135 at the same time as the outdoor module produces cooling.



### *Caution*

It is necessary for "active cooling 4 pipe" to be selected in either "accessories" or "soft in/outputs" to enable activation of "hot water during cooling". The heat pump must also be activated for cooling operation.

## MENU 5.3.15 - GBM COMMUNICATION MODULE

### *start diff additional heat*

Setting range: 10 – 2,000 DM

Factory setting: 700 DM

### *hysteresis*

Setting range: 10 – 2,000 DM

Factory setting: 100 DM

Make settings for the gas boiler GBM 10-15 here. For example . you can select when the gas boiler is to start. See the accessory installation instructions for a description of function.

## MENU 5.3.16 - HUMIDITY SENSOR

### *climate system 1 HTS*

Setting range: 1–4

Default value: 1

### *limit RH in the room, syst.*

Setting range: on/off

Factory setting: off

### *prevent condensation, syst.*

Setting range: on/off

Factory setting: off

### *limit RH in the room, syst.*

Setting range: on/off

Factory setting: off

Up to four humidity sensors (HTS 40) can be installed. Here you select whether your system(s) is/are to limit the relative humidity level (RH) during heating or cooling operation.

You can also choose to limit min. cooling supply and calculated cooling supply to prevent condensation on pipes and components in the cooling system.

See the Installer Manual for HTS 40 for function description.

## MENU 5.3.21 - FLOW SENSOR / ENERGY METER

### *Supply temperature sensor*

#### *set mode*

Setting range: EMK150 / EMK300/310 / EMK500

Factory setting: EMK150

#### *energy per pulse*

Setting range: 0 – 10000 Wh

Factory setting: 1000 Wh

#### *pulses per kWh*

Setting range: 1 – 10000

Factory setting: 500

### *Energy meter*

#### *set mode*

Setting range: energy per pulse / pulses per kWh

Default value: energy per pulse

#### *energy per pulse*

Setting range: 0 – 10000 Wh

Factory setting: 1000 Wh

#### *pulses per kWh*

Setting range: 1 – 10000

Factory setting: 500

Up to two flow sensors (EMK) / energy meters can be connected on the input board AA3, terminal block X22 and X23. Select these in menu 5.2.4 - accessories.

### *Flow sensor (Energy measurement kit EMK)*

A flow sensor (EMK) is used to measure the amount of energy produced and supplied by the heating installation for hot water and heating in the building.

The function of the flow sensor is to measure flow and temperature differences in the charge circuit. The value is presented in the display on a compatible product.

Starting from software version 8801R2, you can select the flow sensor (EMK) you have connected in the system.

*energy per pulse:* Here you set the amount of energy to which each pulse will correspond.

*pulses per kWh:* Here you set the number of pulses per kWh that are sent to SMO 40.



#### **Caution**

The software in SMO 40 must be software version 8801R2 or later. Visit [nibeuplink.com](http://nibeuplink.com) and click on the "Software" tab to download the latest software to your installation.

### *Energy meter (Electricity meter)*

The energy meter(s) is used to send pulse signals every time a certain amount of energy has been consumed.

*energy per pulse:* Here you set the amount of energy to which each pulse will correspond.

*pulses per kWh:* Here you set the number of pulses per kWh that are sent to SMO 40.

## MENU 5.4 - SOFT IN/OUTPUTS

Here you can select which to in/output on the input board (AA3) and the terminal block (X2) the external contact function (page 30) must be connected.

Selectable inputs on terminal blocks AUX 1-6 (AA3-X6:9-14 and X2:1-4) and output AA3-X7.

## MENU 5.5 - FACTORY SETTING SERVICE

All settings can be reset (including settings available to the user) to default values here.



#### **Caution**

When resetting, the start guide is displayed the next time the control module is restarted.

## MENU 5.6 - FORCED CONTROL

You can force control the different components in the control module and any connected accessories here.

## MENU 5.7 - START GUIDE

When the control module is started for the first time the start guide starts automatically. Start it manually here.

See page 35 for more information about the start guide.

## MENU 5.8 - QUICK START

It is possible to start the compressor from here.



#### **Caution**

There must be a heating, cooling or hot water demand to start the compressor.



#### **NOTE**

Do not quick start the compressor too many times over a short period of time, as this could damage the compressor and its surrounding equipment.

## MENU 5.9 - FLOOR DRYING FUNCTION

### *length of period 1 – 7*

Setting range: 0 – 30 days

Factory setting, period 1 – 3, 5 – 7: 2 days

Factory setting, period 4: 3 days

### *temp. period 1 – 7*

Setting range: 15 – 70 °C

Default value:

temp. period 1	20 °C
temp. period 2	30 °C
temp. period 3	40 °C
temp. period 4	45 C
temp. period 5	40 °C
temp. period 6	30 °C
temp. period 7	20 °C

Set the function for under floor drying here.

You can set up to seven period times with different calculated flow temperatures. If less than seven periods are to be used, set the remaining period times to 0 days.

Mark the active window to activate the underfloor drying function. A counter at the bottom shows the number of days the function has been active.



#### TIP

If operating mode "add. heat only" is to be used, select it in menu 4.2.



#### TIP

It is possible to save a floor drying log that shows when the concrete slab has reached the correct temperature. See section "Logging floor drying" on page 57.

## MENU 5.10 - CHANGE LOG

Read off any previous changes to the control system here.

The date, time and ID no. (unique to certain settings) and the new set value is shown for every change.



#### Caution

The change log is saved at restart and remains unchanged after factory setting.

## MENU 5.11 - SLAVE SETTINGS

Settings for installed slaves can be made in the sub menus.

### MENU 5.11.1 - EB101 - 5.11.8 - EB108

Make settings for the installed slaves here.

#### MENU 5.11.1.1 - HEAT PUMP

Make settings for the installed slave here. To see what settings you can make, see installation manual for the relevant installed slave.

## MENU 5.11.1.2 - CHARGE PUMP (GP12)

### *op. mode*

Heating/cooling

Setting range: auto / intermittent

Default value: intermittent

Set the operating mode for the charge pump here.

*auto*: The charge pump runs according to the current operating mode for SMO 40.

*intermittent*: The charge pump starts and stops 20 seconds before, and after, the compressor in the heat pump.

### *speed during operation*

*heating, hot water, pool, cooling*

Setting range: auto / manual

Default value: auto

#### *Manual setting*

Setting range: 1–100 %

Default values: 70 %

#### *min. allowed speed*

Setting range: 1–100 %

Default values: 1 %

#### *speed in wait mode*

Setting range: 1–100 %

Default values: 30 %

#### *max. allowed speed*

Setting range: 80–100 %

Default values: 100 %

Set the speed at which the charge pump is to operate in the present operating mode. Select "auto" if the speed of the charge pump is to be regulated automatically (factory setting) for optimal operation.

If "auto" is activated for heating operation, you can also make the setting "min. allowed speed" and "max. allowed speed", which restricts the charge pump and prevents it from running at a lower or higher speed than the set value.

For manual operation of the charge pump, deactivate "auto" for the current operating mode and set the value to between 1 and 100% (the previously set value for "max. allowed speed" and "min. allowed speed" no longer applies).

*Speed in wait mode* (only used if "auto" has been selected for "Operating mode") means the charge pump operates at the set speed during the time when neither compressor operation nor additional heat are required.

## 5.12 - COUNTRY

Select here where the product was installed. This allows access to country specific settings in your product.

Language settings can be made regardless of this selection.



### *Caution*

This option locks after 24 hours, after restarting the display or program updating.

# 9 Service

## Service actions



### NOTE

Servicing should only be carried out by persons with the necessary expertise.

When replacing components on SMO 40 only replacement parts from NIBE may be used.

### EMERGENCY MODE



### NOTE

Switch (SF1) must not be put into mode "I" or  before the installation is filled with water. The compressor in the heat pump can be damaged.

Emergency mode is used in event of operational interference and in conjunction with service. Hot water is not produced in emergency mode.

Emergency mode is activated by setting switch (SF1) in mode "I". This means that:

- The status lamp illuminates yellow.
- The display is not lit and the control computer is not connected.
- Hot water is not produced.
- The compressors in the heat pumps are switched off. Charge pump (EB101-GP12) and charge pump (EB102-GP12) (if installed) are running.
- Accessories are switched off.
- The heating medium pump is active.
- The emergency mode relay (K2) is active.

External additional heat is active if it is connected to the emergency mode relay (K2, terminal block X1). Ensure that the heating medium circulates through the external additional heat.

### TEMPERATURE SENSOR DATA

Temperature (°C)	Resistance (kOhm)	Voltage (VDC)
-40	351.0	3.256
-35	251.6	3.240
-30	182.5	3.218
-25	133.8	3.189
-20	99.22	3.150
-15	74.32	3.105
-10	56.20	3.047
-5	42.89	2.976
0	33.02	2.889
5	25.61	2.789
10	20.02	2.673
15	15.77	2.541
20	12.51	2.399
25	10.00	2.245
30	8.045	2.083
35	6.514	1.916
40	5.306	1.752
45	4.348	1.587
50	3.583	1.426
55	2.968	1.278
60	2.467	1.136
65	2.068	1.007
70	1.739	0.891
75	1.469	0.785
80	1.246	0.691
85	1.061	0.607
90	0.908	0.533
95	0.779	0.469
100	0.672	0.414

## USB SERVICE OUTLET

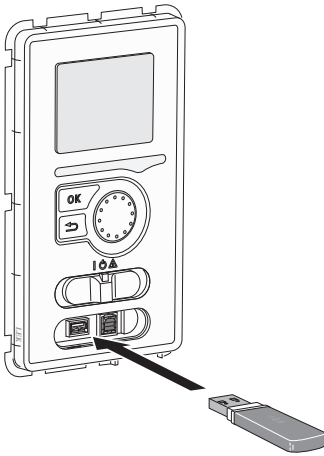

The display unit is equipped with a USB socket that can be used to update the software and save logged information in SMO 40.

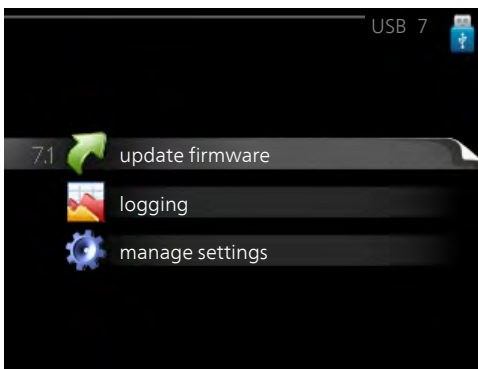
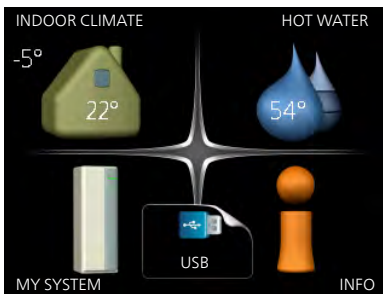

When a USB memory is connected, a new menu (menu 7) appears in the display.

### Menu 7.1 - update firmware

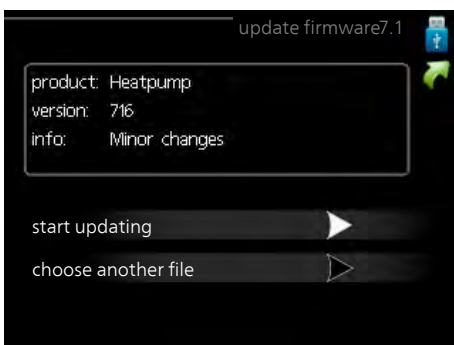

This allows you to update the software in SMO 40.



### NOTE

For the following functions to work the USB memory must contain files with software for SMO 40 from NIBE.

The fact box at the top of the display shows information (always in English) of the most probable update that the update software has selected from the USB memory.

This information states the product for which the software is intended, the software version and general information about it. If you want a file other than the one selected, the correct file can be selected through "choose another file".

### start updating

Select "start updating" if you want to start the update. You are asked whether you really want to update the software. Respond "yes" to continue or "no" to undo.

If you responded "yes" to the previous question the update starts and you can now follow the progress of the update on the display. When the update is complete SMO 40 restarts.



### TIP

A software update does not reset the menu settings in SMO 40.



### Caution

If the update is interrupted before it is complete (for example power cut etc.), the software can be reset to the previous version if the OK button is held in during start up until the green lamp starts to illuminate (takes about 10 seconds).

### choose another file



Select "choose another file" if you do not want to use the suggested software. When you scroll through the files, information about the marked software is shown in a fact box just as before. When you have selected a file with the OK button you will return to the previous page (menu 7.1) where you can choose to start the update.



## Menu 7.2 - logging

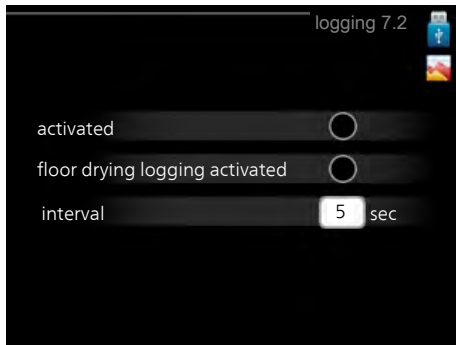

Setting range: 1 s – 60 min  
Factory setting range: 5 s

Here you can choose how current measurement values from SMO 40 should be saved onto a log file on the USB memory.

1. Set the desired interval between loggings.
2. Tick "activated".
3. The present values from SMO 40 are saved in a file in the USB memory at the set interval until "activated" is unticked.



### Caution

Untick "activated" before removing the USB memory.

## Logging floor drying

Here you can save a floor drying log on the USB memory and in this way see when the concrete slab reached the correct temperature.

- Make sure that "floor drying function" is activated in menu 5.9.
- Select "logging floor drying activated".
- A log file is now created, where the temperature and the immersion heater output can be read off. Logging continues until "logging floor drying activated" is deselected or until "floor drying function" is stopped.



### Caution

Deselect "logging floor drying activated" before you remove the USB memory.

## Menu 7.3 - manage settings

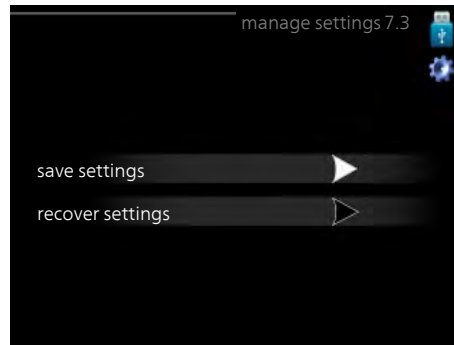

Here you can manage (save as or retrieve from) all the menu settings (user and service menus) in SMO 40 with a USB memory.

Via "save settings" you save the menu settings to the USB memory in order to restore them later or to copy the settings to another SMO 40.



### Caution

When you save the menu settings to the USB memory you replace any previously saved settings on the USB memory.

Via "recover settings" you reset all menu settings from the USB memory.



### Caution

Reset of the menu settings from the USB memory cannot be undone.

# 10 Disturbances in comfort

In most cases, SMO 40 notes a malfunction (a malfunction can lead to disruption in comfort) and indicates this with alarms, and instructions for action, in the display.

## Info-menu

All the installation's measurement values are gathered under menu 3.1 in the control module's menu system. Examining the values in this menu can often make it easier to identify the source of the fault.

## Manage alarm

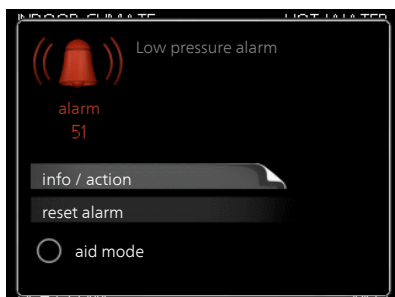

In the event of an alarm, some kind of malfunction has occurred, which is indicated by the status lamp changing from green continuously to red continuously. In addition, an alarm bell appears in the information window.

### ALARM

In the event of an alarm with a red status lamp a malfunction has occurred that the heat pump and/or control module cannot remedy itself. In the display, by turning the control knob and pressing the OK button, you can see the type of alarm it is and reset it. You can also choose to set the installation to aid mode.

*info / action* Here you can read what the alarm means and receive tips on what you can do to correct the problem that caused the alarm.

*reset alarm* In many cases, it is sufficient to select "reset alarm" for the product to revert to normal operation. If a green light comes on after selecting "reset alarm", the alarm has been remedied. If the red light is still on, and a menu called "alarm" is visible in the display, the problem causing the alarm still remains.

*aid mode* "aid mode" is a type of emergency mode. This means that the installation produces heat and/or hot water even if there is some kind of problem. This could mean that the heat pump's compressor is not in operation. In this case, any electric additional heat produces heat and/or hot water.



### Caution

To select aid mode an alarm action must be selected in the menu 5.1.4.



### Caution

Selecting "aid mode" is not the same as correcting the problem that caused the alarm. The status lamp will therefore continue to be red.

If the operational interference is not shown in the display the following tips can be used:

### BASIC ACTIONS

Start by checking the following items:

- The switch's (SF1) position.
- Group and main fuses of the accommodation.
- Miniature circuit breaker for SMO 40 (FA1).
- The property's earth circuit breaker.
- Correctly set load monitor (if installed).

## LOW HOT WATER TEMPERATURE OR A LACK OF HOT WATER

This part of the fault-tracing chapter only applies if the water heater is installed in the system.

- Closed or choked filling valve for the hot water.
  - Open the valve.
- Mixing valve (if there is one installed) set too low.
  - Adjust the mixer valve.
- SMO 40 in incorrect operating mode.
  - Enter menu 4.2. If mode "auto" is selected, select a higher value on "stop additional heat" in menu 4.9.2.
  - If mode "manual" is selected, select "addition".
- Large hot water consumption.
  - Wait until the hot water has heated up. Temporarily increased hot water capacity (temporary lux) can be activated in menu 2.1.
- Too low hot water setting.
  - Enter menu 2.2 and select a higher comfort mode.
- Low hot water access with the "Smart Control" function active.
  - If the hot water usage has been low, the installation will produce less hot water than normal. Restart the installation
- Too low or no operating prioritisation of hot water.
  - Enter menu 4.9.1 and increase the time for when hot water is to be prioritised. Note that if the time for hot water is increased, the time for heating production is reduced, which can give lower/uneven room temperatures.
- "Holiday mode" activated in menu 4.7.
  - Enter menu 4.7 and select "Off".

## LOW ROOM TEMPERATURE

- Closed thermostats in several rooms.
  - Set the thermostats to max, in as many rooms as possible. Adjust the room temperature via menu 1.1, instead of choking the thermostats.
- SMO 40 in incorrect operating mode.
  - Enter menu 4.2. If mode "auto" is selected, select a higher value on "stop heating" in menu 4.9.2.
  - If mode "manual" is selected, select "heating". If this is not enough, select "addition".
- Too low set value on the automatic heating control.
  - Enter menu 1.1 "temperature" and adjust the offset heating curve up. If the room temperature is only low in cold weather the curve slope in menu 1.9.1 "heating curve" needs adjusting up.

- Too low or no operating prioritisation of heat.
  - Enter menu 4.9.1 and increase the time for when heating is to be prioritised. Note that if the time for heating is increased the time for hot water production is reduced, which can give smaller amounts of hot water.
- "Holiday mode" activated in menu 4.7.
  - Enter menu 4.7 and select "Off".
- External switch for changing the room heating activated.
  - Check any external switches.
- Air in the climate system.
  - Vent the climate system.
- Closed valves to the climate system or heat pump.
  - Open the valves.

## HIGH ROOM TEMPERATURE

- Too high set value on the automatic heating control.
  - Enter menu 1.1 (temperature) and reduce the offset heating curve. If the room temperature is only high in cold weather the curve slope in menu 1.9.1 "heating curve" needs adjusting down.
- External switch for changing the room heating activated.
  - Check any external switches.

## LOW SYSTEM PRESSURE

- Not enough water in the climate system.
  - Fill the climate system with water and check for leaks. In event of repeated filling, contact the installer.

## THE AIR/WATER HEAT PUMP'S COMPRESSOR DOES NOT START

- There is no heating requirement.
  - SMO 40 does not call on heating or hot water.
- Compressor blocked due to the temperature conditions.
  - Wait until the temperature is within the product's working range.
- Minimum time between compressor starts has not been reached.
  - Wait for at least 30 minutes and then check if the compressor has started.
- Alarm tripped.
  - Follow the display instructions.

# Additional heating only

If you are unsuccessful in rectifying the fault and are unable to heat the house, you can, whilst waiting for assistance, continue running the heat pump in "add. heat only". This means that additional heating only is used to heat the house.

## SET THE INSTALLATION TO ADDITIONAL HEAT MODE

1. Go to menu 4.2 op. mode.
2. Mark "add. heat only" using the control knob and then press the OK button.
3. Return to the main menus by pressing the Back button.



### *Caution*

When commissioning without NIBE air/water heat pump, the "communication error" alarm may appear in the display.

The alarm is reset if the relevant air/water heat pump is deactivated in menu 5.2.2 ("installed slaves").

# 11 Accessories

Not all accessories are available on all markets.

## ACCESSORY CARD AXC 30

An accessory board for active cooling (4-pipe system), extra climate system, hot water comfort or if more than four charge pumps are to be connected to SMO 40. It can also be used for step controlled additional heat (e.g. external electric boiler), shunt controlled additional heat (e.g. wood/oil/gas/pellet boiler).

An accessory board is required if for example an HWC pump is to be connected to SMO 40 at the same time that the common alarm indication is activated.

Part no. 067 304

## AUXILIARY RELAY HR 10

Auxiliary relay HR 10 is used to control external 1 to 3 phase loads such as oil burners, immersion heaters and pumps.

Part no 067 309

## CHARGE PUMP CPD 11

Charge pump for heat pump

*CPD 11-25/65*

*CPD 11-25/75*

Part no. 067 321

Part no. 067 320

## COMMUNICATION MODULE FOR SOLAR ELECTRICITY EME 20

EME 20 is used to enable communication and control between inverters for solar cells from NIBE and SMO 40.

Part no. 057 188

## COMMUNICATIONS MODULE MODBUS 40

MODBUS 40 enables SMO 40 to be controlled and monitored using a DUC (computer sub-centre) in the building. Communication is then performed using MODBUS-RTU.

Part no 067 144

## COMMUNICATIONS MODULE SMS 40

When there is no internet connection, you can use the accessory SMS 40 to control SMO 40 via SMS.

Part no 067 073

## CONNECTION BOX K11

Connection box with thermostat and overheating protection. (When connecting Immersion heater IU)

Part no. 018 893

## DOCKING KIT SOLAR 40

Solar 40 means that SMO 40 (together with VPAS) can be connected to thermal solar heating.

Part no 067 084

## DOCKING KIT SOLAR 42

Part no 067 153

## ENERGY MEASUREMENT KIT EMK 300

This accessory is installed externally and used to measure the amount of energy that is supplied for the pool, hot water, heating and cooling in the building.

Part no. 067 314

## ENERGY MEASUREMENT KIT EMK 500

This accessory is installed externally and used to measure the amount of energy that is supplied for the pool, hot water, heating and cooling in the building.

Cu pipe Ø28.

Part no. 067 178

## EXHAUST AIR HEAT PUMP F135

F135 is an exhaust air heat pump specially designed to combine the recovery of mechanical exhaust air with air/water heat pump. Indoor module/control module controls F135.

Part no. 066 075

## EXTERNAL ELECTRIC ADDITIONAL HEAT ELK

These accessories may need an accessory board AXC 30 (step controlled additional heat).

### *ELK 5*

Immersion heater  
5 kW, 1 x 230 V  
Part no. 069 025

### *ELK 8*

Immersion heater  
8 kW, 1 x 230 V  
Part no. 069 026

### *ELK 15*

15 kW, 3 x 400 V  
Part no. 069 022

### *ELK 26*

26 kW, 3 x 400 V  
Part no. 067 074

### *ELK 42*

42 kW, 3 x 400 V  
Part no. 067 075

## EXTRA SHUNT GROUP ECS 40/ECS 41

This accessory is used when SMO 40 is installed in houses with two or more different heating systems that require different supply temperatures.

### *ECS 40 (Max 80 m<sup>2</sup>)*

Part no 067 287

### *ECS 41 (approx. 80-250 m<sup>2</sup>)*

Part no 067 288

## GAS ACCESSORY

### *Gas boiler GBM 10-15*

Part no. 069 122

### *Communications module OPT 10*

OPT 10 is used to enable connection and control of gas boiler NIBE GBM 10-15.

Part no. 067 513

## HOT WATER CONTROL

### *VST 05*

Reversing valve, Cu pipe Ø22 mm  
Max. heat pump size 8 kW  
Part no. 089 982

### *VST 11*

Reversing valve, Cu pipe Ø28 mm  
Max. recommended power, 17 kW  
Part no. 089 152

### *VST 20*

Reversing valve, Cu pipe Ø35 mm  
(Max. recommended capacity, 40 kW)  
Part no 089 388

## IMMERSION HEATER IU

### *3 kW*

Part no. 018 084

### *6 kW*

Part no. 018 088

### *9 kW*

Part no. 018 090

## MEASUREMENT KIT FOR SOLAR GENERATED ELECTRICITY EME 10

EME 10 is used to optimise the use of solar generated electricity. EME 10 measures the relevant current from the inverter via a current transformer and can work with all inverters.

Part no. 067 541

## POOL HEATING POOL 40

POOL 40 is used to enable pool heating with SMO 40.

Part no 067 062

## REVERSING VALVE FOR COOLING

### *VCC 05*

Reversing valve, Cu pipe Ø22 mm  
Part no. 067 311

### *VCC 11*

Reversing valve, Cu pipe Ø28 mm  
Part no. 067 312

## ROOM SENSORRTS 40

This accessory is used to obtain a more even indoor temperature.

Part no. 067 065

## ROOM UNIT RMU 40

The room unit is an accessory that allows the control and monitoring of SMO 40 to be carried out in a different part of your home to where it is located.

Part no 067 064

## WATER HEATER/ACCUMULATOR TANK

### *AHPS*

Accumulator tank without an immersion heater with solar coil (copper) and a hot water coil (stainless steel).

Part no. 056 283

### *AHPH*

Accumulator tank without an immersion heater with integrated hot water coil (stainless steel).

Part no. 081 036

## VPA

Water heater with double-jacketed vessel.

### VPA 450/300

Copper Part no. 088 660  
Enamel Part no. 088 670

## VPB

Water heater without immersion heater with charging coil.

### VPB 200

Copper Part no. 088 515  
Enamel Part no. 088 517  
Stainless steel Part no. 088 518

### VPB 300

Copper Part no. 083 009  
Enamel Part no. 083 011  
Stainless steel Part no. 083 010

### VPB 500

Copper Part no. 083 220

### VPB 750-2

Copper Part no. 083 231

### VPB 1000

Copper Part no. 083 240

## VPAS

Water heater with double-jacketed vessel and solar coil.

### VPAS 300/450

Copper Part no. 087 720  
Enamel Part no. 087 710

# 12 Technical data

## Dimensions

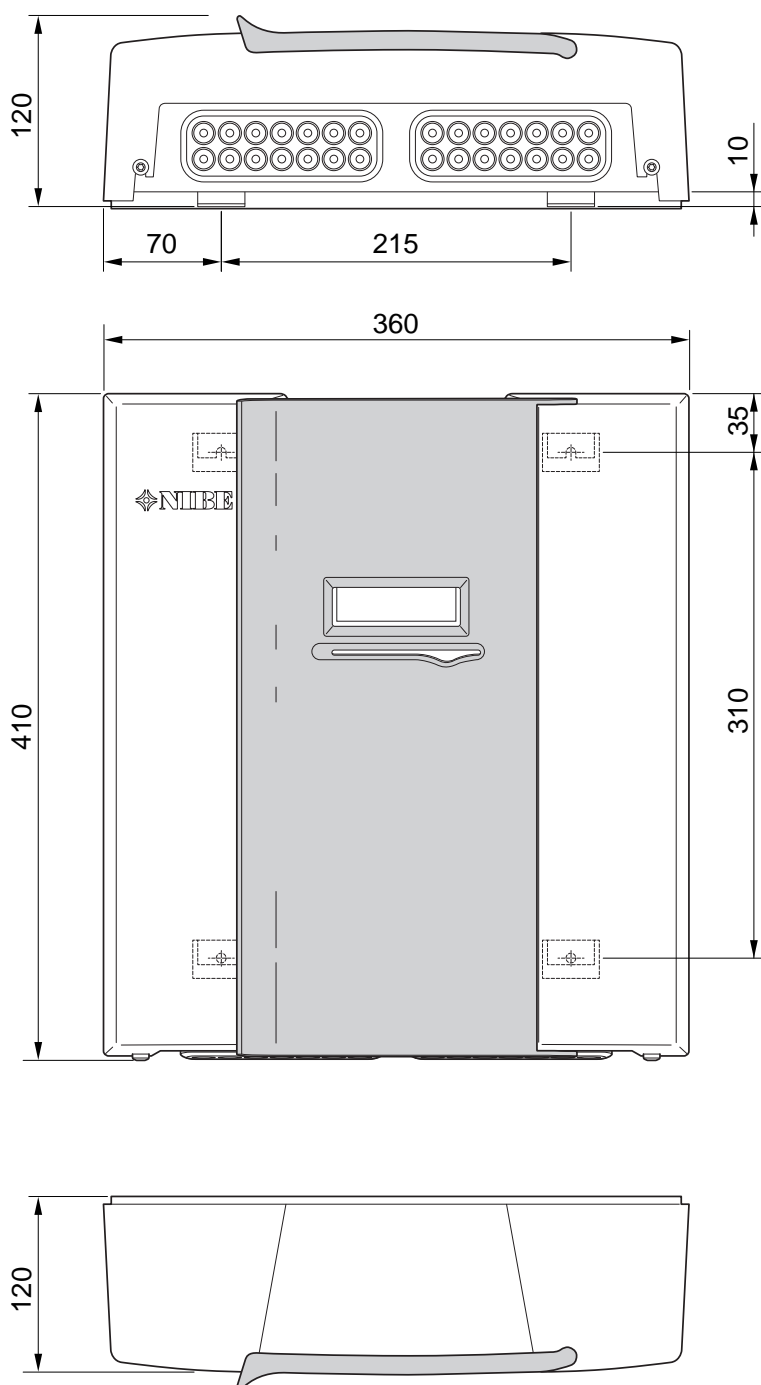



# Technical specifications

<i>SMO 40</i>		
<i>Electrical data</i>		
Supply voltage		230V~ 50Hz
Enclosure class		IP21
Rated value for impulse voltage	kV	4
Pollution degree		2
Fuse	A	10
<i>Optional connections</i>		
Max number air/water heat pumps		8
Max number of sensors		8
Max number of charge pumps with internal accessory cards		4
Max number of charge pumps with external accessory cards		8
Max number of outputs for additional heat step		3
<i>Miscellaneous</i>		
Operation mode (EN60730)		Type 1
Area of operation	°C	-25 – 70
Ambient temperature	°C	5 – 35
Program cycles, hours		1, 24
Program cycles, days		1, 2, 5, 7
Resolution, program	min.	1
<i>Dimensions and weight</i>		
Width	mm	360
Depth	mm	120
Height	mm	410
Weight, (without packaging and enclosed components)	kg	5.15
<i>Miscellaneous</i>		
Part no. SMO 40		067 225

# Energy labelling

<i>Supplier</i>		<i>NIBE</i>
<i>Model</i>		<i>SMO 40 + F2040 / F2120</i>
Controller, class		VI
Controller, contribution to efficiency	%	4.0

# Electrical circuit diagram

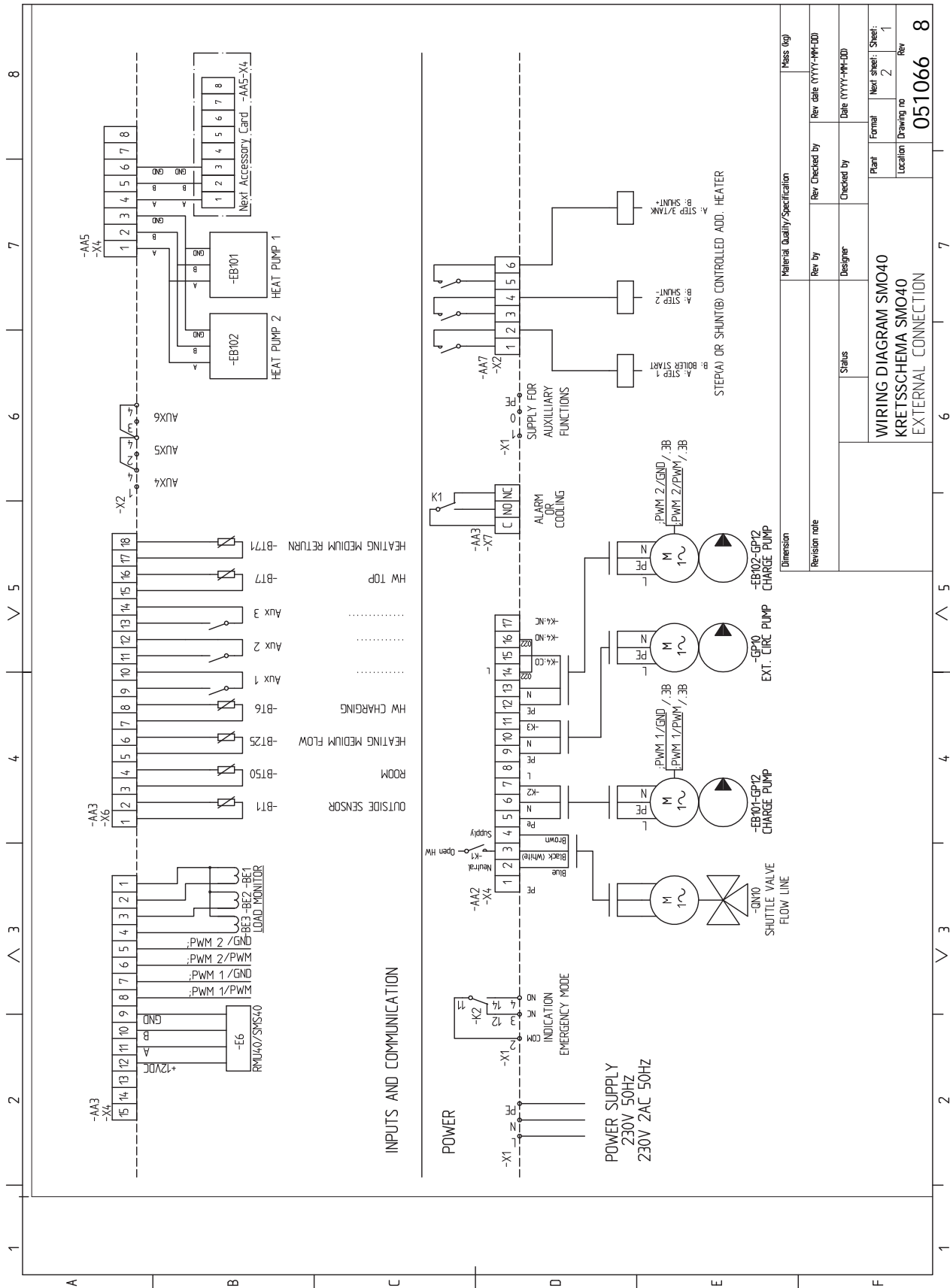

Material Quality/Specification		Revision rate	
Rev. by	Rev. Checked by	Rev. date (YYYY-MM-DD)	Dimension
Designer	Checked by	Date (YYYY-MM-DD)	Mass (kg)
Status	WIRING DIAGRAM SMO40		
KRETSCHEMA SMO40			Plant
EXTERNAL CONNECTION			Formal
			Location
			Next sheet: Sheet: 1
			Drawing no
			Rev
			<b>051066</b>
			<b>8</b>

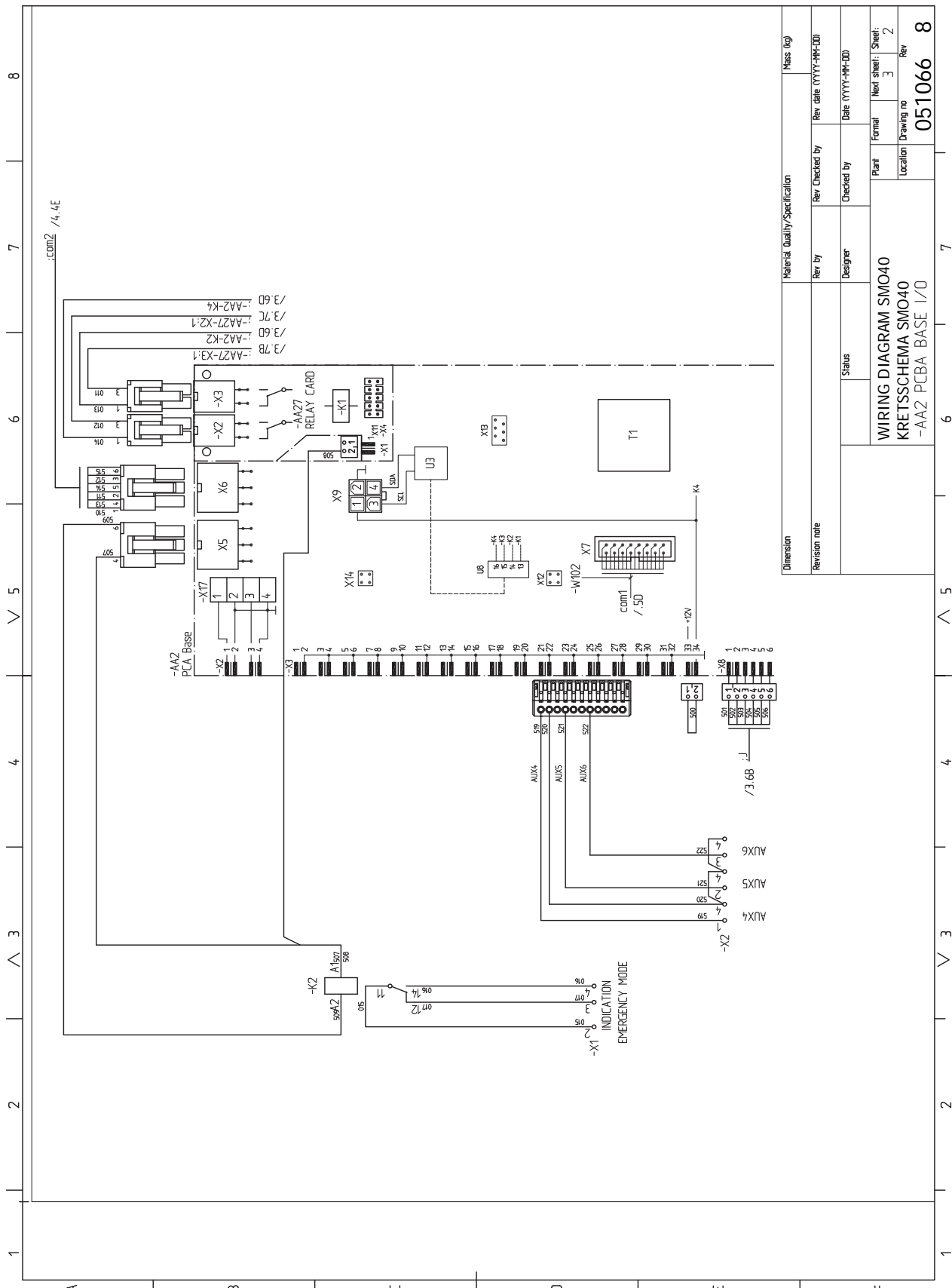

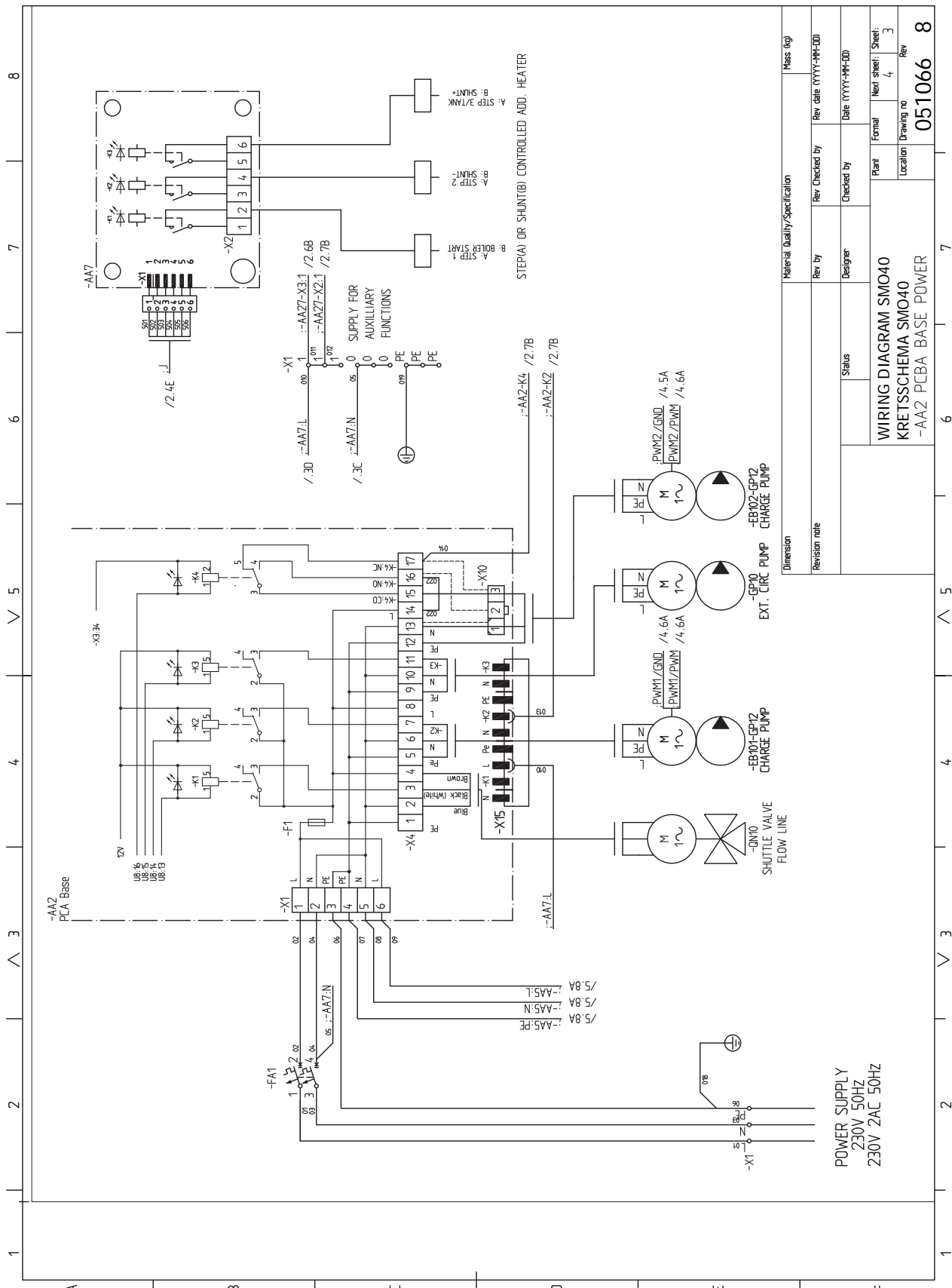

POWER SUPPLY  
230V 50HZ  
230V 2AC 50HZ

Material Quality/Specification		Revision rate	
Rev. by	Rev. Checked by	Rev. date (YYYY-MM-DD)	Rev. date (YYYY-MM-DD)
Designer	Checked by	Date (YYYY-MM-DD)	Date (YYYY-MM-DD)
Status	Plant	Formal	Next sheet / Sheet:
	Location	Drawing no	4 / 3
		Rev	051066
		Rev	8



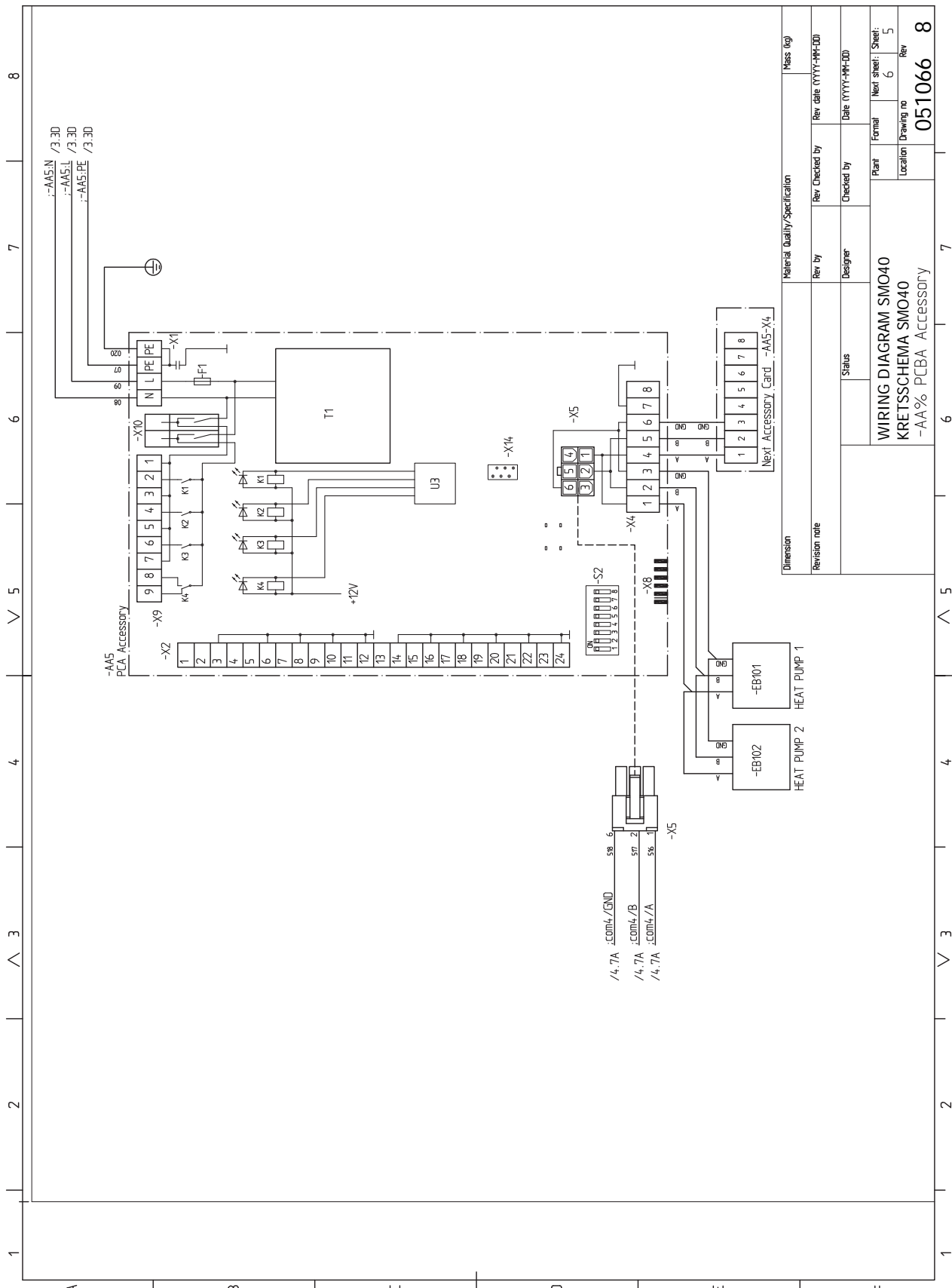

Material Quality/Specification		Miss (kg)	
Revision rate	Rev. by	Rev. Checked by	Rev. date (YYYY-MM-DD)
Status	Designer	Checked by	Date (YYYY-MM-DD)
WIRING DIAGRAM SMO40		Plant	Formal
KRETSCHEMA SMO40		Location	Next sheet / Sheet:
-AA% PCBA ACCESSORY		Drawing no	6 / 5
		Rev	051066
			8

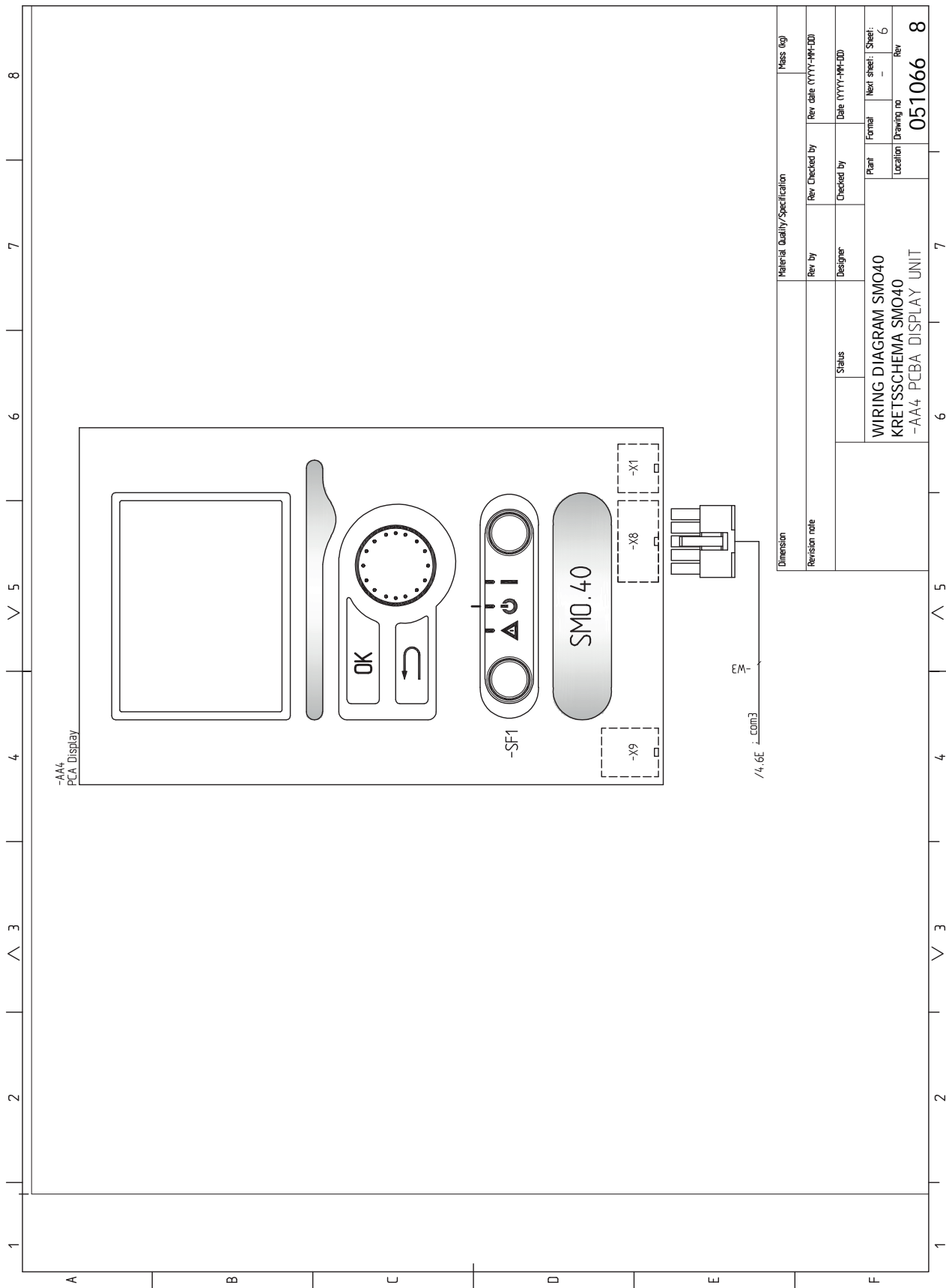





# Item register

- A**
  - Accessibility, electrical connection, 20
  - Accessories, 61
  - Alarm, 58
- B**
  - Back button, 36
- C**
  - Cable lock, 21
  - Commissioning and adjusting, 34
    - Commissioning with additional heating only, 34
    - Commissioning with NIBE air/water heat pump, 34
    - Cooling mode, 34
    - Preparations, 34
    - Start guide, 35
  - Commissioning with additional heating only, 34
  - Commissioning with NIBE air/water heat pump, 34
  - Communication with heat pump, 23
  - Connecting accessories, 33
  - Connecting current sensors, 27
  - Connecting the charge pump for the heat pump, 22
  - Connections, 22
  - Control, 36, 40
    - Control - Introduction, 36
    - Control - Menus, 40
  - Control - Introduction, 36
    - Display unit, 36
    - Menu system, 37
  - Control knob, 36
  - Control - Menus, 40
    - Menu 5 - SERVICE, 43
  - Cooling mode, 34
  - Cooling mode indication, 31
- D**
  - Delivery and handling, 9
    - Mounting, 9
    - Supplied components, 9
  - Dimensions and setting-out coordinates, 64
  - Display, 36
  - Display unit, 36
    - Back button, 36
    - Control knob, 36
    - Display, 36
    - OK button, 36
    - Status lamp, 36
    - Switch, 36
- Disturbances in comfort, 58
  - Alarm, 58
  - Manage alarm, 58
  - Only additional heat, 60
  - Troubleshooting, 58
- Docking alternatives, 13
- E**
  - Electrical circuit diagram, 67
  - Electrical connections, 19
    - Accessibility, electrical connection, 20
    - Cable lock, 21
    - Communication with heat pump, 23
    - Connecting accessories, 33
    - Connecting the charge pump for the heat pump, 22
    - Connections, 22
    - External circulation pump, 29
    - External connection options (AUX), 30
    - General, 19
    - Load monitor, 27
    - Miniature circuit-breaker, 19
    - NIBE Uplink, 29
    - Optional connections, 27
    - Outdoor sensor, 25
    - Power connection, 22
    - Relay output for emergency mode, 29
    - Reversing valve, 29
    - Room sensor, 25
    - Shunt controlled additional heat, 28
    - Step controlled additional heat, 27
    - Temperature sensor, external flow line, 26
    - Temperature sensor, external return line, 26
    - Temperature sensor, hot water charging, 26
  - Energy labelling, 66
  - External circulation pump, 29
  - External connection options
    - Possible selections for AUX output, 31
    - Temperature sensor, hot water top, 26
  - External connection options (AUX), 30
    - Cooling mode indication, 31
    - Extra circulation pump, 31
    - Hot water circulation, 31
    - Optional selection for AUX output (potential-free variable relay), 31
  - Extra circulation pump, 31
- H**
  - Help menu, 35, 39

Hot water circulation, 31

## I

Important information, 4

Inspection of the installation, 6

Marking, 4

Recovery, 5

Safety information, 4

Serial number, 5

Symbols, 4

System solutions, 7

Inspection of the installation, 6

## L

Load monitor, 27

## M

Manage alarm, 58

Marking, 4

Menu 5 - SERVICE, 43

Menu system, 37

Help menu, 35, 39

Operation, 38

Scroll through the windows, 39

Selecting menu, 38

Selecting options, 38

Setting a value, 38

Use the virtual keyboard, 39

Miniature circuit-breaker, 19

Mounting, 9

## N

NIBE Uplink, 29

## O

OK button, 36

Only additional heat, 60

Operation, 38

Optional connections, 27

Possible selections for AUX inputs, 30

Outdoor sensor, 25

## P

Pipe connections, 11

Docking alternatives, 13

General, 11

Symbol key, 12

Possible selection for AUX inputs, 30

Possible selection for AUX output (potential free variable relay), 31

Possible selections for AUX output, 31

Power connection, 22

Preparations, 34

## R

Recovery, 5

Relay output for emergency mode, 29

Reversing valve, 29

Room sensor, 25

## S

Safety information, 4

Marking, 4

Serial number, 5

Symbols on SMO 40, 4

Scroll through the windows, 39

Selecting menu, 38

Selecting options, 38

Serial number, 5

Service, 55

Service actions, 55

Service actions, 55

Standby mode, 55

Temperature sensor data, 55

USB service outlet, 56

Setting a value, 38

Shunt controlled additional heat, 28

Standby mode, 55

Start guide, 35

Status lamp, 36

Step controlled additional heat, 27

Supplied components, 9

Switch, 36

Symbol key, 12

Symbols, 4

Symbols on SMO 40, 4

System solutions, 7

## T

Technical data, 64

Dimensions and setting-out coordinates, 64

Electrical circuit diagram, 67

Temperature sensor, external flow line, 26

Temperature sensor, external return line, 26

Temperature sensor, hot water charging, 26

Temperature sensor, hot water top, 26

Temperature sensor data, 55

The Control Module Design, 10

Component locations, 10

List of components, 10

Troubleshooting, 58

## U

USB service outlet, 56

Use the virtual keyboard, 39







# Contact information

## AUSTRIA

KNV Energietechnik GmbH  
Gahberggasse 11, 4861 Schörfling  
Tel: +43 (0)7662 8963-0  
mail@knv.at  
knv.at

## CZECH REPUBLIC

Družstevní závody Dražice - strojírna  
s.r.o.  
Dražice 69, 29471 Benátky n. Jiz.  
Tel: +420 326 373 801  
nibe@nibe.cz  
nibe.cz

## DENMARK

Vølund Varmeteknik A/S  
Industrivej Nord 7B, 7400 Herning  
Tel: +45 97 17 20 33  
info@volundvt.dk  
volundvt.dk

## FINLAND

NIBE Energy Systems Oy  
Juurakotie 3, 01510 Vantaa  
Tel: +358 (0)9 274 6970  
info@nibe.fi  
nibe.fi

## FRANCE

NIBE Energy Systems France SAS  
Zone industrielle RD 28  
Rue du Pou du Ciel, 01600 Reyrieux  
Tél: 04 74 00 92 92  
info@nibe.fr  
nibe.fr

## GERMANY

NIBE Systemtechnik GmbH  
Am Reiherpfahl 3, 29223 Celle  
Tel: +49 (0)5141 75 46 -0  
info@nibe.de  
nibe.de

## GREAT BRITAIN

NIBE Energy Systems Ltd  
3C Broom Business Park,  
Bridge Way, S41 9QG Chesterfield  
Tel: +44 (0)845 095 1200  
info@nibe.co.uk  
nibe.co.uk

## NETHERLANDS

NIBE Energietechnik B.V.  
Energieweg 31, 4906 CG Oosterhout  
Tel: +31 (0)168 47 77 22  
info@nibenl.nl  
nibenl.nl

## NORWAY

ABK AS  
Brobekkveien 80, 0582 Oslo  
Tel: (+47) 23 17 05 20  
post@abkklima.no  
nibe.no

## POLAND

NIBE-BIAWAR Sp. z o.o.  
Al. Jana Pawla II 57, 15-703 Białystok  
Tel: +48 (0)85 66 28 490  
biawar.com.pl

## RUSSIA

EVAN  
bld. 8, Yuliusa Fuchika str.  
603024 Nizhny Novgorod  
Tel: +7 831 419 57 06  
kuzmin@evan.ru  
nibe-evan.ru

## SWEDEN

NIBE Energy Systems  
Box 14  
Hannabadvägen 5, 285 21 Markaryd  
Tel: +46 (0)433-27 3000  
info@nibe.se  
nibe.se

## SWITZERLAND

NIBE Wärmetechnik c/o ait Schweiz  
AG  
Industriepark, CH-6246 Altishofen  
Tel. +41 (0)58 252 21 00  
info@nibe.ch  
nibe.ch

For countries not mentioned in this list, contact NIBE Sweden or check [nibe.eu](http://nibe.eu) for more information.

NIBE Energy Systems  
Hannabadsvägen 5  
Box 14  
SE-285 21 Markaryd  
info@nibe.se  
nibe.eu

IHB EN 1918-6 231760

This manual is a publication from NIBE Energy Systems. All product illustrations, facts and data are based on the available information at the time of the publication's approval. NIBE Energy Systems makes reservations for any factual or printing errors in this manual.

©2019 NIBE ENERGY SYSTEMS

